

EAC-2000 USER

NVIDIA® Jetson Xavier™ NX Edge AI Computing System
4 GigE LAN with 2 PoE+, 4 GMSL, -20°C to 70°C Operation

Manual

Record of Revision

Version	Date	Page	Description	Remark
1.00	2021/12/08	All	Official Release	
1.10	2022/03/14	53	Update	
1.20	2022/05/20	55	Update	
1.30	2022/06/01	55	Update	
1.40	2022/06/24	4, 6	Update	
1.50	2023/04/27	3, 5, 54	Update	
1.60	2023/06/09	55	Update	

Disclaimer

This manual is released by Vecow Co., Ltd. for reference purpose only. All product offerings and specifications are subject to change without prior notice. It does not represent commitment of Vecow Co., Ltd. Vecow shall not be liable for direct, indirect, special, incidental, or consequential damages arising out of the use of the product or documentation or any infringements upon the rights of third parties, which may result from such use.

Declaration of Conformity

FCC This equipment has been tested and found to comply with the limits for a Class A digital device, pursuant to part 15 of the FCC Rules. These limits are designed to provide reasonable protection against harmful interference when the equipment is operated in a commercial environment. This equipment generates, uses, and can radiate radio frequency energy, and if it is not installed and used in accordance with the instruction manual, it may cause harmful interference to radio communications. Operation of this equipment in a residential area is likely to cause harmful interference in which case the user will be required to correct the interference at his own expense.

CE The products described in this manual complies with all applicable European Union (CE) directives if it has a CE marking. For computer systems to remain CE compliant, only CE-compliant parts may be used. Maintaining CE compliance also requires proper cable and cabling techniques.

Copyright and Trademarks

This document contains proprietary information protected by copyright. No part of this publication may be reproduced in any form or by any means, electric, photocopying, recording or otherwise, without prior written authorization by Vecow Co., Ltd. The rights of all the brand names, product names, and trademarks belong to their respective owners.

Order Information

Part Number	Description
EAC-2000	NVIDIA® Jetson Xavier™ NX Edge AI Computing System, 4 GigE LAN with 2 PoE+, 4 USB 3.1, 2 COM RS-232/485, 1 SIM, -20°C to 70°C
EAC-2100	NVIDIA® Jetson Xavier™ NX Edge AI Computing System, 4 GigE LAN with 2 PoE+, 4 USB 3.1, 2 COM RS-232/485, 1 SIM, 4 GMSL, 1 CAN Bus, -20°C to 70°C

Optional Accessories

Part Number	Description
PWA-120W	120W, 24V, 90V AC to 264V AC Power Adapter with 3-pin Terminal Block
PWA-160W-WT	160W, 24V, 85V AC to 264V AC Power Adapter with 3-pin Terminal Block, Wide Temperature -30°C to +70°C
DIN-RAIL	DIN Rail Kit
GMSL Camera Kit	GMSL Camera with Fakra-Z connector
M.2 Storage Module	M.2 Key M/Key B PCIe Storage Module
5G Module	5G Module with Antenna
4G Module	4G/GPS Module with Antenna
WiFi & Bluetooth Module	WiFi & Bluetooth Module with Antenna

Table of Contents

CHAPTER 1	GENERAL INTRODUCTION	1
1.1	Overview	1
1.2	Features	2
1.3	Product Specification	3
1.3.1	Specifications of EAC-2000	3
1.3.2	Specifications of EAC-2100	5
1.4	Mechanical Dimension	7
1.4.1	Dimensions of EAC-2000	7
1.4.2	Dimensions of EAC-2100	7
CHAPTER 2	GETTING TO KNOW YOUR EAC-2000/2100	8
2.1	Packing List	8
2.1.1	EAC-2000 Packing List	8
2.1.2	EAC-2100 Packing List	9
2.2	Front Panel I/O & Functions	10
2.3	Rear Panel I/O & Functions	18
2.4	Main Board Connector & Jumper Locations	23
2.5	Main Board Jumper Settings	31
2.6	Expansion Board Connectors & Jumper Locations	34
CHAPTER 3	SYSTEM SETUP	40
3.1	How to Open Your EAC-2000/2100	40
3.2	Installing Nano SIM Card	41
3.3	Installing Micro SD Card	42
3.4	Installing M.2	43
3.5	Installing Antenna Cable	45
3.6	Mounting Your EAC-2000/2100	46

CHAPTER 4	SOFTWARE SETUP	47
4.1	Peripheral Interface Guide	47
4.2	Determine Available Drive Space	49
4.3	Install the CUDA package	49
4.4	Flash image to Your EAC-2000/2100	49
APPENDIX A	GMSL Camera Guide (EAC-2100 only)	52
APPENDIX B	Power Consumption	53
APPENDIX C	Supported Expansion Module List	55

1

GENERAL INTRODUCTION

1.1 Overview

Vecow EAC-2000 Series is an Arm-based Edge AI Computing System. Powered by NVIDIA® Jetson Xavier™ NX module, Vecow EAC-2000 Series delivers great power efficiency in a small form factor. Featuring 4 GMSL automotive cameras via rugged FAKRA-Z connectors, EAC-2000 is well suited for industrial and outdoor environments.

Vecow EAC-2000 is based on the new NVIDIA® Jetson Xavier™ NX module that provides more than 10x the performance of its widely adopted predecessor, NVIDIA Jetson TX2. The EAC-2000 is equipped with 4 GigE LAN including 2 PoE+ to simplify cable installations and deployments, 6 antennas to enable seamless connectivity, and 1 CANBus to offer faster and robust communication between vehicles.

With support for operating temperature from -20°C to 70°C, 9V to 50V wide range DC-in, along with GMSL technology linked with Fakra-Z connectors, EAC-2000 Series brings small size and easy deployment of AI vision and industrial applications including Traffic Vision, Public Safety, Auto Optical Inspection, Smart Factory, AMR/AGV, and any AIoT/Industry 4.0 applications.

1.2 Features

- Small form factor NVIDIA® Jetson Xavier™ NX supports up to 21 TOPS AI performance
- Advanced NVIDIA Volta™ architecture with 384 NVIDIA®CUDA® cores and 48 Tensor cores
- Fanless -20°C to 70°C operation
- 4 GigE LAN with 2 PoE⁺, 4 USB 3.1, 1 Digital Display
- Supports 4 GMSL 1/2 automotive cameras with Fakra-Z connectors
- M.2 for 5G/4G/LTE/WiFi/BT/GPRS/UMTS
- Storage : M.2 PCIe NVMe SSD, External Micro SD
- DV 9V to 50V wide range power input

1.3 Product Specification

1.3.1 Specifications of EAC-2000

System	
Processor	NVIDIA® Jetson Xavier™ NX System-On-Module <ul style="list-style-type: none"> • 6-core NVIDIA Carmel ARM® v8.2 64-bit CPU • 384-core NVIDIA Volta™ GPU with 48 Tensor Cores
Memory	1 LPDDR4x DRAM, 8GB
Storage	eMMC 5.1, 16 GB
Software Support	<ul style="list-style-type: none"> • Linux • NVIDIA JetPack SDK
Ethernet	
LAN 1	10/100/1000 Base-T Ethernet GigE LAN, RJ45 Connector
LAN 2	10/100/1000 Base-T Ethernet GigE LAN, RJ45 Connector
PoE	
LAN 3	10/100/1000 Base-T Ethernet GigE PoE ⁺ LAN, RJ45 Connector
LAN 4	10/100/1000 Base-T Ethernet GigE PoE ⁺ LAN, RJ45 Connector
Graphics	
Interface	1 Digital Display
Video Encode	<ul style="list-style-type: none"> • 2x 4K @30 (HEVC) • 6x 1080p @60 (HEVC) • 14x 1080p @30 (HEVC)
Video Decode	<ul style="list-style-type: none"> • 2x 4K @60 (HEVC) • 4x 4K @30 (HEVC) • 12x 1080p @60 (HEVC) • 32x 1080p @30 (HEVC) • 16x 1080p @30 (H.264)
I/O Interface	
USB	4 USB 3.1 Type A
Serial	2 COM RS-232/485
Button	<ul style="list-style-type: none"> • 1 User-define Button • 1 Force Recovery Button
SIM	1 Nano SIM Card Socket
LED	2 PoE, 2 User Programming
Antenna	6 Antenna for 5G/WiFi/4G/LTE/GPRS/UMTS
Expansion	
M.2	<ul style="list-style-type: none"> • 1 M.2 Key B Socket (3042/3052) • 1 M.2 Key E Socket (2230)
Storage	
SD	1 Micro SD Socket (External)

M.2	1 M.2 Key M Socket (2280)
Power	
Power Input	9V to 50V, DC-in
Power Interface	3-pin Terminal Block : V+, V-, Frame Ground
Mechanical	
Dimensions	150.4mm x 106.2mm x 50.0mm (5.92" x 4.18" x 1.97")
Weight	1.2 kg (2.6 lb)
Mounting	<ul style="list-style-type: none"> • Wallmount by mounting bracket • DIN Rail Mount (optional)
Environment	
Operating Temperature	15W TDP Mode : -20°C to 65°C (-4°F to 149°F), with air flow 10W TDP Mode : -20°C to 70°C (-4°F to 158°F), with air flow
Storage Temperature	-40°C to 85°C (-40°F to 185°F)
Humidity	5% to 95% Humidity, non-condensing
Relative Humidity	95% at 70°C
Shock	Operating, MIL-STD-810G, Method 516.7, Procedure I
Vibration	Operating, MIL-STD-810G, Method 514.7, Procedure I, Category 4
EMC	CE, FCC, EN50155, EN50121-3-2

1.3.2 Specifications of EAC-2100

System	
Processor	NVIDIA® Jetson Xavier™ NX System-On-Module <ul style="list-style-type: none"> • 6-core NVIDIA Carmel ARM® v8.2 64-bit CPU • 384-core NVIDIA Volta™ GPU with 48 Tensor Cores
Memory	1 LPDDR4x DRAM, 8GB
Storage	eMMC 5.1, 16 GB
Software Support	<ul style="list-style-type: none"> • Linux • NVIDIA JetPack SDK
Ethernet	
LAN 1	10/100/1000 Base-T Ethernet GigE LAN, RJ45 Connector
LAN 2	10/100/1000 Base-T Ethernet GigE LAN, RJ45 Connector
PoE	
LAN 3	10/100/1000 Base-T Ethernet GigE PoE+ LAN, RJ45 Connector
LAN 4	10/100/1000 Base-T Ethernet GigE PoE+ LAN, RJ45 Connector
Graphics	
Interface	1 Digital Display
Video Encode	<ul style="list-style-type: none"> • 2x 4K @30 (HEVC) • 6x 1080p @60 (HEVC) • 14x 1080p @30 (HEVC)
Video Decode	<ul style="list-style-type: none"> • 2x 4K @60 (HEVC) • 4x 4K @30 (HEVC) • 12x 1080p @60 (HEVC) • 32x 1080p @30 (HEVC) • 16x 1080p @30 (H.264)
Camera	
GMSL	4 Fakra-Z connectors for GMSL 1/2 automotive cameras
I/O Interface	
USB	4 USB 3.1 Type A
Serial	2 COM RS-232/485
CAN Bus	1 CAN Bus 2.0 A/B
Button	<ul style="list-style-type: none"> • 1 User-define Button • 1 Force Recovery Button
SIM	1 Nano SIM Card Socket
LED	2 PoE, 2 User Programming
Antenna	6 Antenna for 5G/WiFi/4G/LTE/GPRS/UMTS
Expansion	
M.2	<ul style="list-style-type: none"> • 1 M.2 Key B Socket (3042/3052) • 1 M.2 Key E Socket (2230)
Storage	
SD	1 Micro SD Socket (External)

M.2	1 M.2 Key M Socket (2280)
Power	
Power Input	9V to 50V, DC-in
Power Interface	3-pin Terminal Block : V+, V-, Frame Ground
Mechanical	
Dimensions	150.4mm x 106.2mm x 62.0mm (5.92" x 4.18" x 2.44")
Weight	1.3 kg (2.9 lb)
Mounting	<ul style="list-style-type: none"> • Wallmount by mounting bracket • DIN Rail Mount (optional)
Environment	
Operating Temperature	15W TDP Mode : -20°C to 65°C (-4°F to 149°F), with air flow 10W TDP Mode : -20°C to 70°C (-4°F to 158°F), with air flow
Storage Temperature	-40°C to 85°C (-40°F to 185°F)
Humidity	5% to 95% Humidity, non-condensing
Relative Humidity	95% at 70°C
Shock	Operating, MIL-STD-810G, Method 516.7, Procedure I
Vibration	Operating, MIL-STD-810G, Method 514.7, Procedure I, Category 4
EMC	CE, FCC, EN50155, EN50121-3-2

1.4 Mechanical Dimension

1.4.1 Dimensions of EAC-2000

Unit : mm (inch)

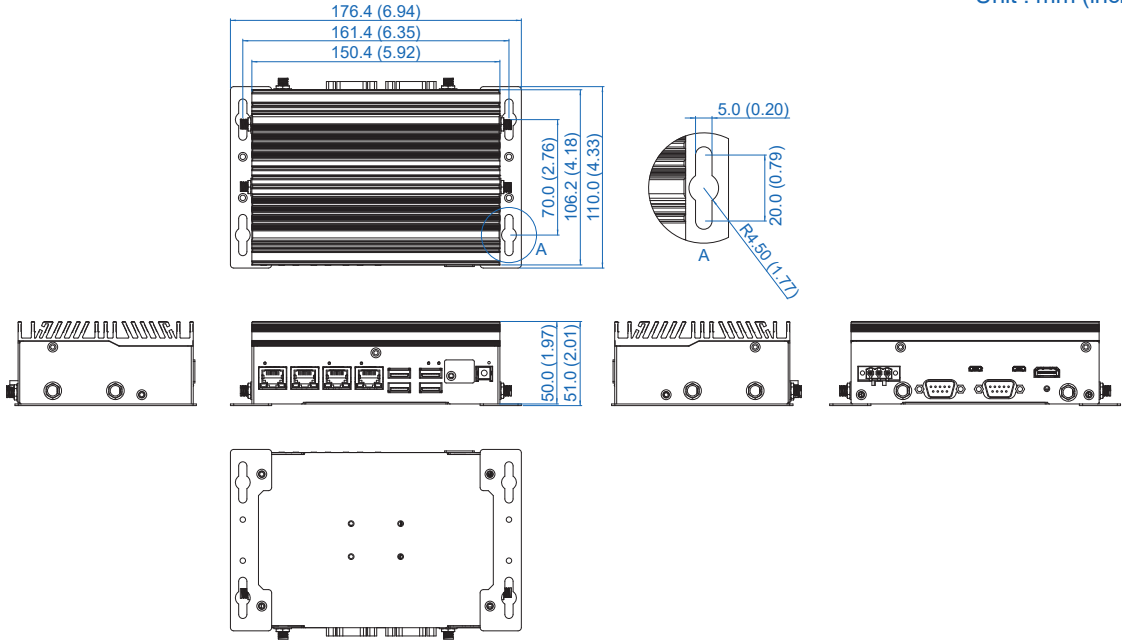

1.4.2 Dimensions of EAC-2100

Unit : mm (inch)

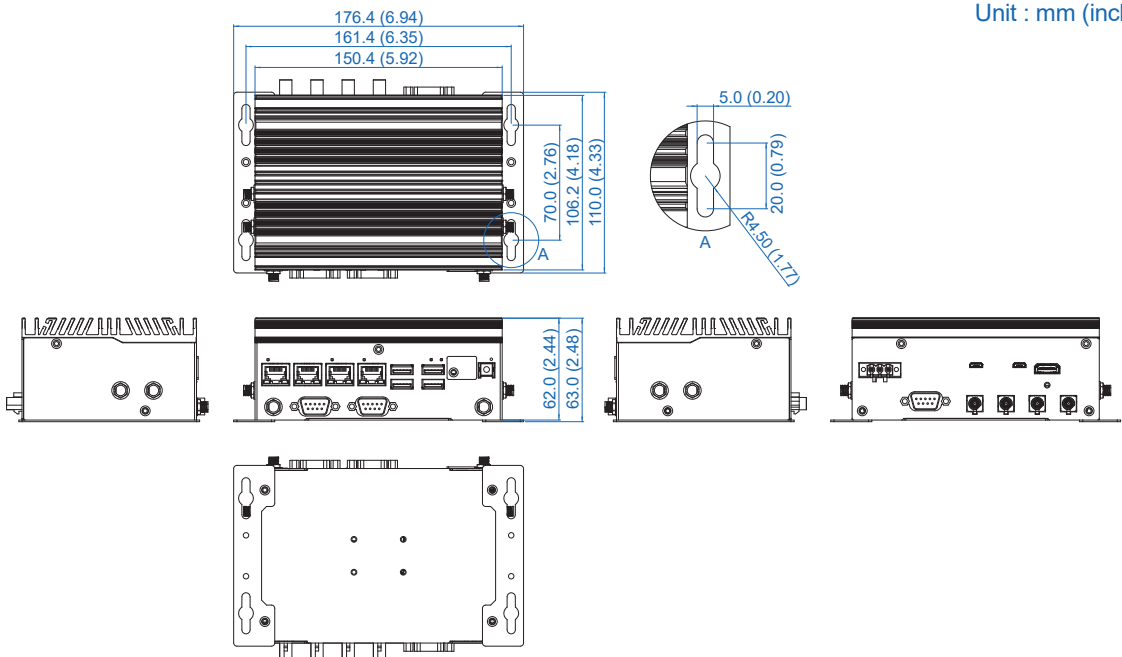





2

GETTING TO KNOW YOUR EAC-2000/2100

2.1 Packing List





2.1.1 EAC-2000 Packing List

Item	Description	Qty
1	EAC-2000 Edge AI Computing System (According to the configuration of your order, EAC-2000 series may contain Micro SD and M.2 modules. Please verify these items if necessary.)	1

Item	Description	Outlook	Usage	P/N	Qty
1	Terminal block 3-pin (5.0mm)		DC-IN	51-2411R03-S1B	1
2	PHILLPIS M3x4L, Ni+Ny		M.2 socket	53-2426204-80B	3
3	Flat M3x4L		Fasten wall mount bracket to EAC-2000	53-2466204-30B	4
4	Wall mount bracket		Wall mount bracket	62-03P0929-0BA	2

2.1.2 EAC-2100 Packing List

Item	Description	Qty
1	EAC-2100 Edge AI Computing System (According to the configuration of your order, EAC-2100 series may contain Micro SD and M.2 modules. Please verify these items if necessary.)	1

Item	Description	Outlook	Usage	P/N	Qty
1	Terminal block 3-pin (5.0mm)		DC-IN	51-2411R03-S1B	1
2	PHILLPIS M3x4L, Ni+Ny		M.2 socket	53-2426204-80B	3
3	Flat M3x4L		Fasten wall mount bracket to EAC-2000	53-2466204-30B	4
4	Wall mount bracket		Wall mount bracket	62-03P0929-0BA	2

2.2 Front Panel I/O & Functions

2.2.1 Functions of EAC-2000

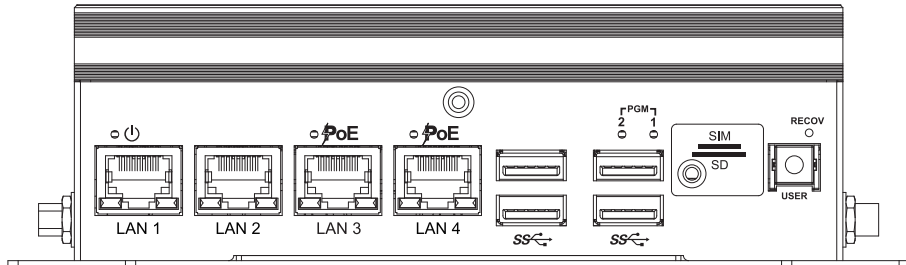

In Vecow EAC-2000 series, Most of the I/O connectors are located on the front panels. Most of the general connections to computer devices, such as USB, LAN, Force Recovery button, User-Define Button, indicators are placed on the front panel.

2.2.1.1 Force Recovery button

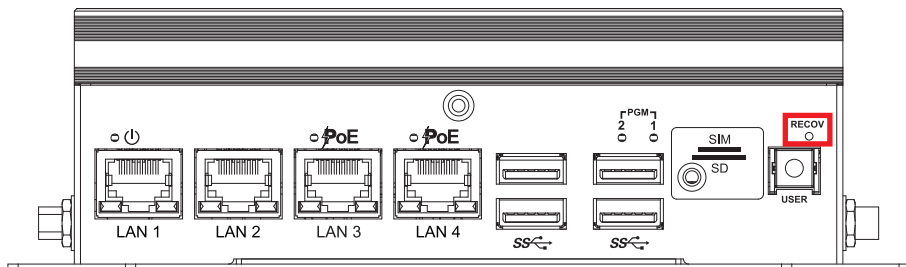

Used to enter Force Recovery Mode. Button is held down while either system is first powered on to put system in USB Force Recovery mode.

2.2.1.2 User-Define Button

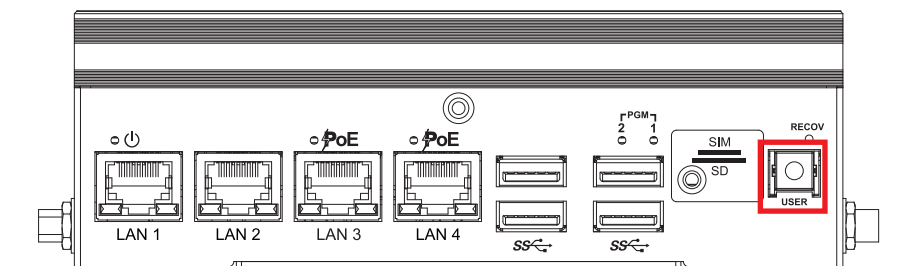

EAC-2000 is also equipped with a Programmable Button for users' easy maintenance.

2.2.1.3 Nano SIM

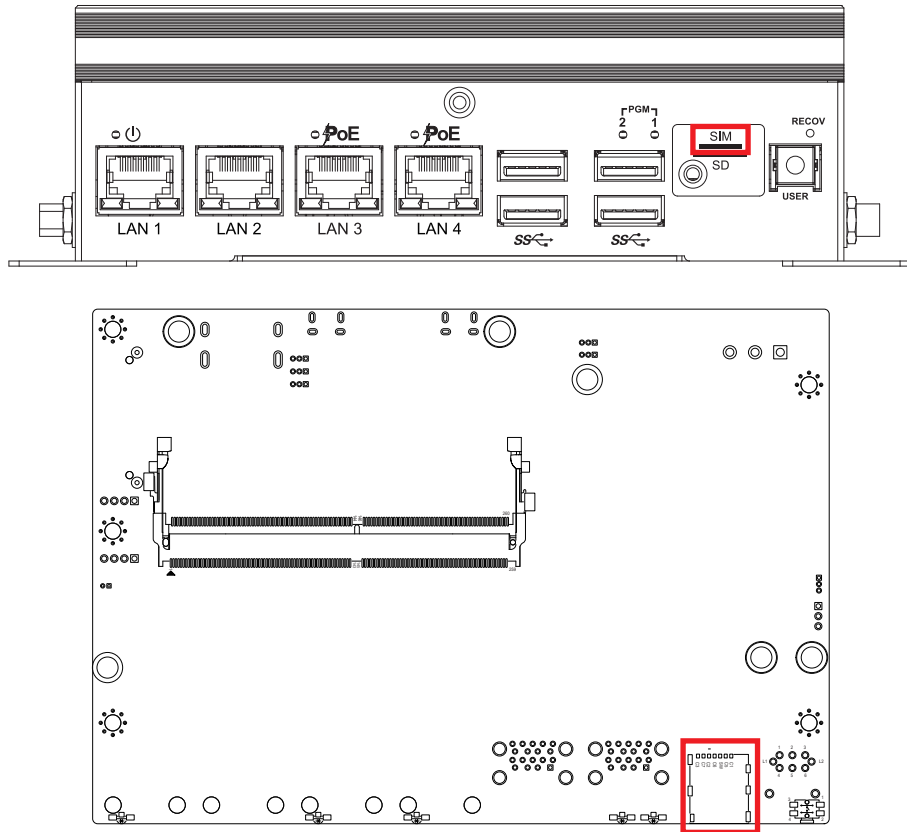

The external Nano SIM card offers wireless communication capability to the system.

2.2.1.4 Micro SD

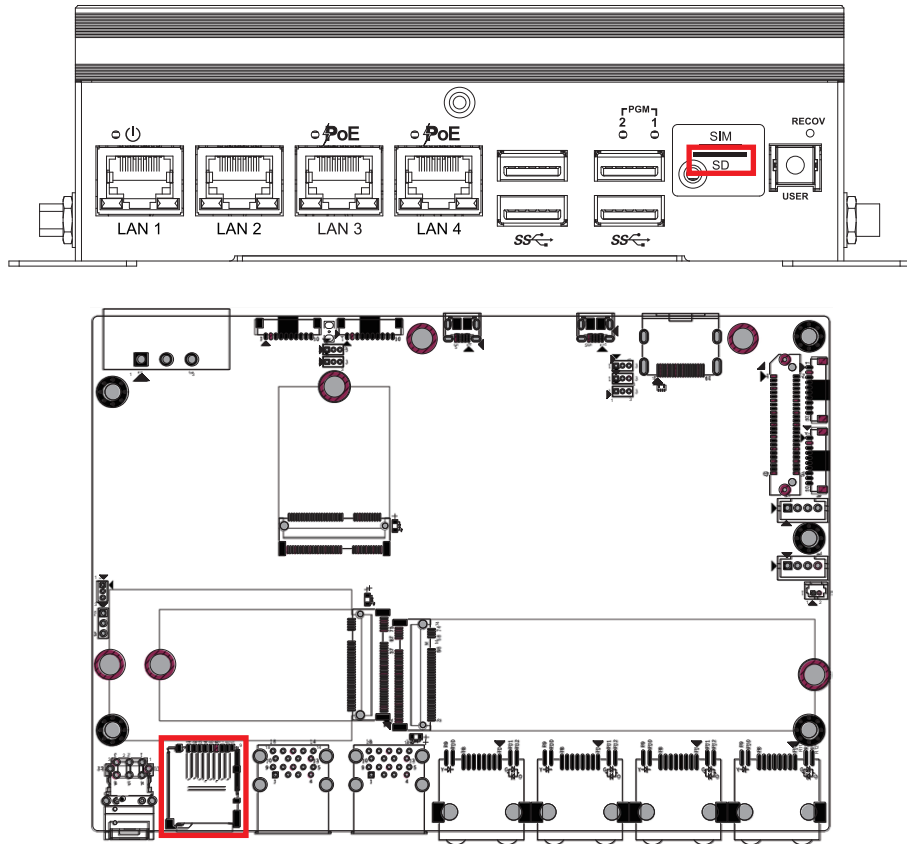

The external Micro SD card provides additional storage expansion. It is located behind the cover-plate on the front panel.

2.2.1.5 Two user Programmable LEDs

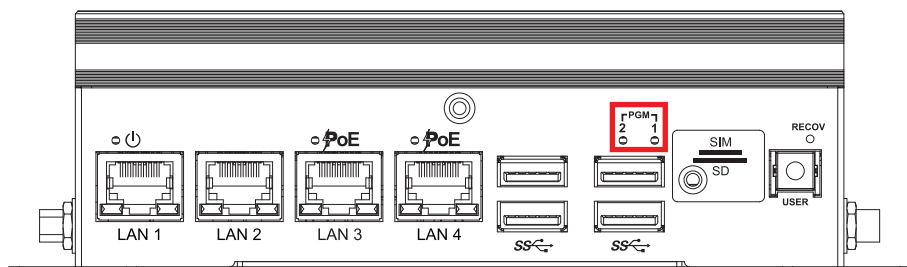

There are two Programmable LEDs, user can define the state of the LED by himself.

2.2.1.6 USB 3.0

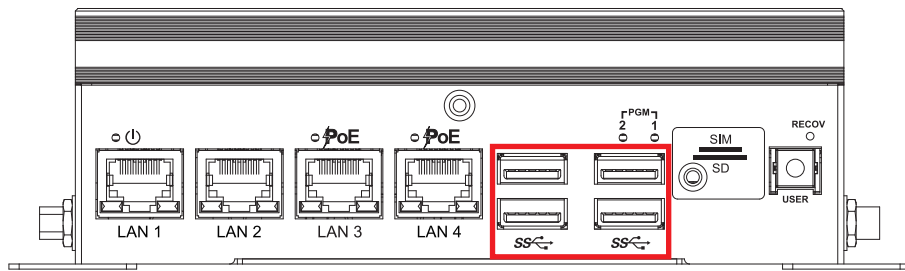

There are 4 USB 3.0 connections available supporting up to 5Gb per second data rate in the front panel of EAC-2000. It is also compliant with the requirements of Speed (SS), High Speed (HS), Full Speed (FS) and Low Speed (LS).

2.2.1.7 LAN 3, LAN 4 : PoE Ports

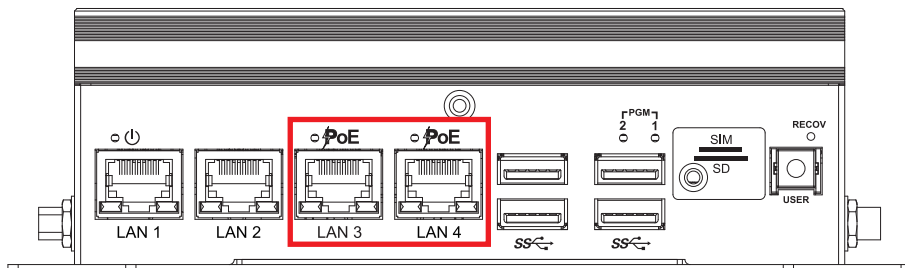

There are 2 RJ45 connectors in the front panel of EAC-2000. It supports IEEE 802.3at (PoE⁺) Power over Ethernet (PoE) connection delivering up to 37W/54V per port and 1000BASE-T gigabit data signals over standard Ethernet Cat 5/ Cat 6 cable. Each PoE connection is powered by Intel[®] I350 Gigabit Ethernet controller and independent PCI express interface to connect with multi-core processor for network and data transmit optimization. Only when PoE port starts to supply power to power devices, the dedicated LED will be lightened.

PS. Suggest to use PoE function when power input is over 12V.

The pin-outs of LAN 3 and LAN 4 are listed as follows :

Pin No.	10/100 Mbps	1000Mbps	PoE
1	E_TX+	MDI0_P	PoE+
2	E_TX-	MDI0_N	PoE+
3	E_RX+	MDI1_P	PoE-
4	-----	MDI2_P	-----
5	-----	MDI2_N	-----
6	E_RX-	MDI1_N	PoE-
7	-----	MDI3_P	-----
8	-----	MDI3_N	-----

Each LAN port is supported by standard RJ-45 connector with LED indicators to present Active/Link/Speed status of the connection.

The LED indicator on the right bottom corner lightens in solid green when the cable is properly connected to a 100Mbps Ethernet network; The LED indicator on the right bottom corner lightens in solid orange when the cable is properly connected to a 1000Mbps Ethernet network; The left LED will keep twinkling/off when Ethernet data packets are being transmitted/received.

LED Location	LED Color	10Mbps	100Mbps	1000Mbps
Right	Green/ Orange	Off	Solid Green	Solid Orange
Left	Yellow	Twinkling Yellow	Twinkling Yellow	Twinkling Yellow

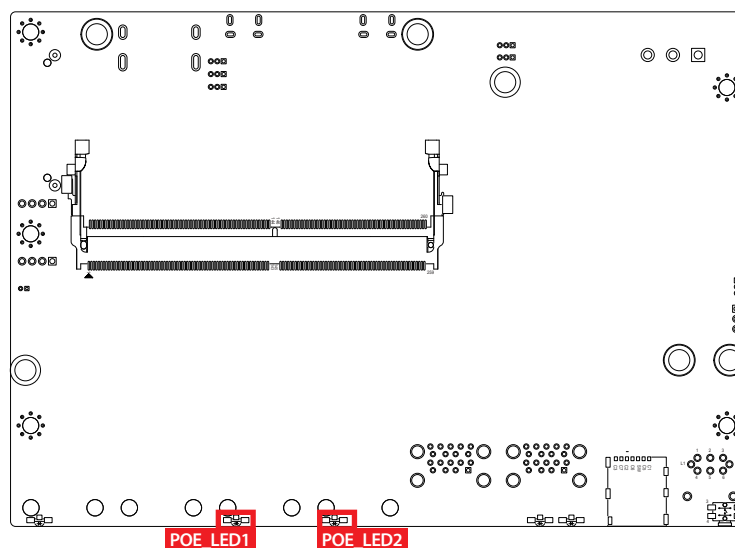
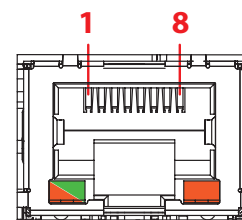

POE LED	LED Color	POE Status
POE_LED1	Solid Orange	POE ON
POE_LED2	Solid Orange	POE ON

2.2.1.8 LAN 1, LAN 2 10/100/1000 Mbps Ethernet Port

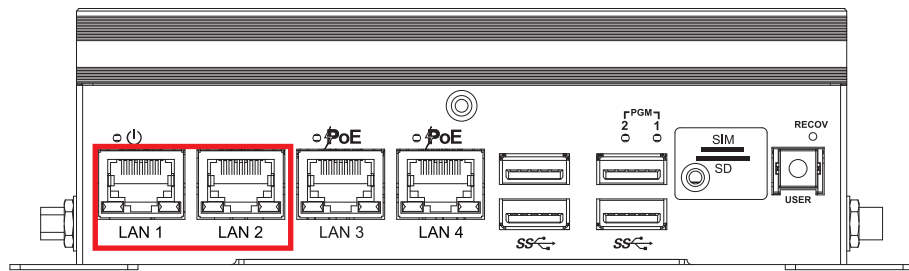

There are two 8-pin RJ-45 jacks supporting 10/100/1000 Mbps Ethernet connections on the front panel of EAC-2000. LAN 1 and LAN 2 are powered by Intel® I350 Ethernet engine.

- Intel® I350 Gigabit Ethernet Controller supports 1Gbps data rate
- IEEE 802.3 Fast Ethernet over optical fiber standard compliant
- IEEE 1588 Precision Time Protocol (PTP)
- Up to 9.5KB Jumbo Frame
- Dual 100BASE-FX fiber ports

Using suitable RJ-45 cable, you can connect the EAC-2000 system to a computer or to any other devices with Ethernet connection, for example, a hub or a switch. The pinouts of LAN 1 and LAN 2 are listed in the following chart :

Pin No.	10/100 Mbps	1000Mbps
1	E_TX+	MDI0_P
2	E_TX-	MDI0_N
3	E_RX+	MDI1_P
4	----	MDI2_P
5	----	MDI2_N
6	E_RX-	MDI1_N
7	----	MDI3_P
8	-----	MDI3_N

Each LAN port is supported by a standard RJ-45 connector with LED indicators to present active/link/speed statuses of the connection.

The LED indicator on the right bottom corner becomes solid green when the cable is properly connected to a 100Mbps Ethernet network; it becomes solid orange when the cable is properly connected to a 1000Mbps Ethernet network. The left LED will keep blinking off when Ethernet data packets are being transmitted or received.

LED Location	LED Color	10Mbps	100Mbps	1000Mbps
Right	Green/ Orange	Off	Solid Green	Solid Orange
Left	Yellow	Twinkling Yellow	Twinkling Yellow	Twinkling Yellow

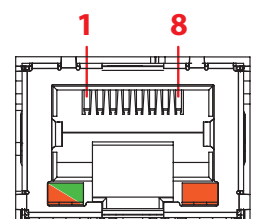

2.2.1.9 PWR & Status LED Indicators

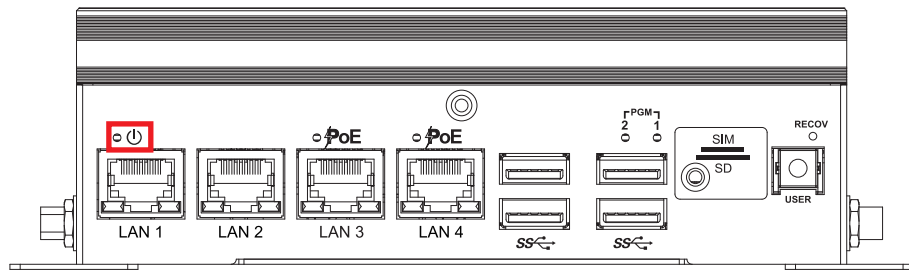

LED Color	System Status
Orange (PWR LED)	+V3.3 Power Ready

2.2.2 Functions of EAC-2100

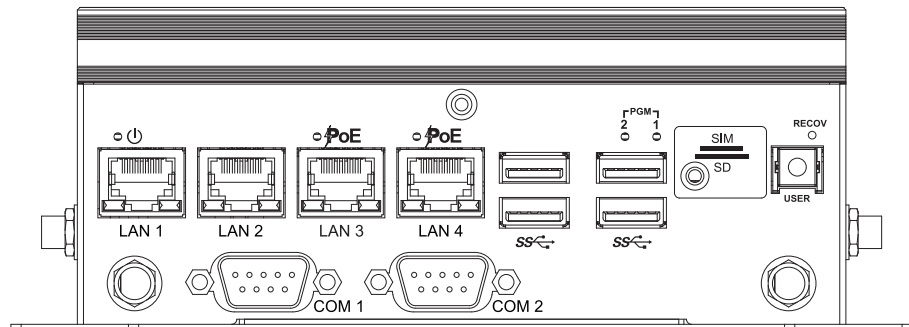

On the front panel, there are two additional COM Port connectors in EAC-2100 Series.

2.2.2.1 COM Port

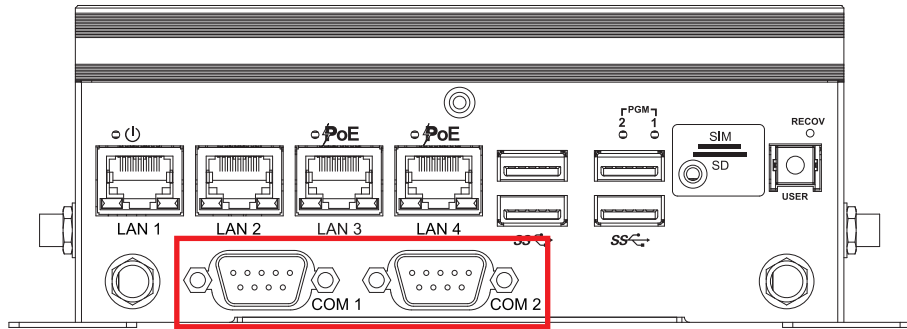

There are two Serial ports (COM1, COM2) can be configured for RS-232 or RS-485 mode. In RS-485 mode it needs to change the Jumper setting to on/off terminal resistor. Please refer to CH 2.5.4.

Software Setting	Function
COM 1	RS-232
COM 2	RS-485

The pin assignments are listed in the following table :

COM Port	Pin No.	RS-232	RS-485 (3-wire)
1, 2	1	-----	DATA-
	2	RXD	DATA+
	3	TXD	-----
	4	-----	-----
	5	GND	GND
	6	-----	-----
	7	RTS	-----
	8	CTS	-----
	9	-----	-----
	9	-----	-----

2.3 Rear Panel I/O & Functions

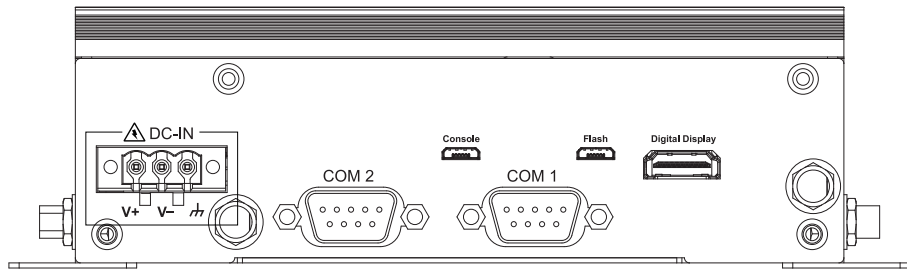

The DC-in connector, COM ports, Micro USB ports, and Digital Display are on the rear panel of the EAC-2000.

2.3.1.1 Power Terminal Block

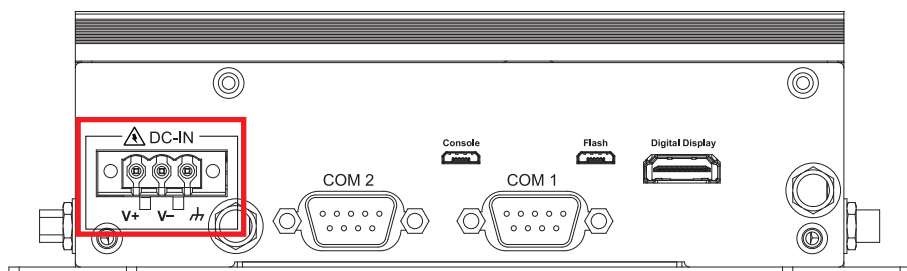

EAC-2000 supports 9V to 50V DC wide range power input by terminal block in the rear side.

Pin No.	Definition
1	V+
2	V-
3	Chassis Ground

2.3.1.2 COM Port

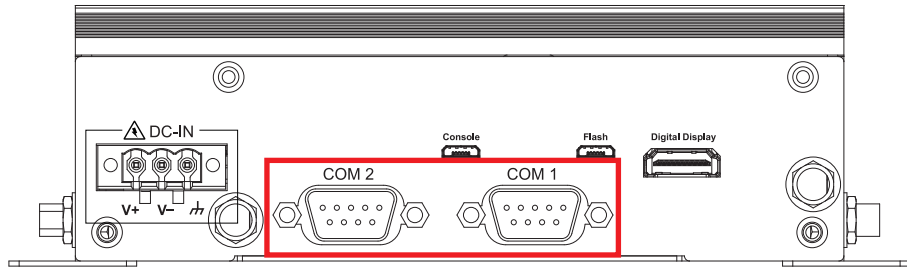

There are two Serial ports (COM1, COM2) can be configured for RS-232 or RS-485 mode. In RS-485 mode it needs to change the Jumper setting to on/off terminal resistor. Please refer to CH 2.5.4.

Software Setting	Function
COM 1	RS-232
COM 2	RS-485

The pin assignments are listed in the following table :

COM Port	Pin No.	RS-232	RS-485 (3-wire)
1, 2	1	-----	DATA-
	2	RXD	DATA+
	3	TXD	-----
	4	-----	-----
	5	GND	GND
	6	-----	-----
	7	RTS	-----
	8	CTS	-----
	9	-----	-----

COM 1 & COM 2 MB connector table :

COM Port	MB Connector	COM Port	MB Connector
COM 1	JCOM1	COM 2	JCOM2

COM 1 & COM 2 MB connector pin out :

CN	Pin No.	Signal Name	Pin No.	Signal Name
JCOM1 JCOM2	1	-----	2	GND
	3	-----	4	-----
	5	CTS	6	TXD
	7	RTS	8	RXD/D+
	9	-----	10	D-

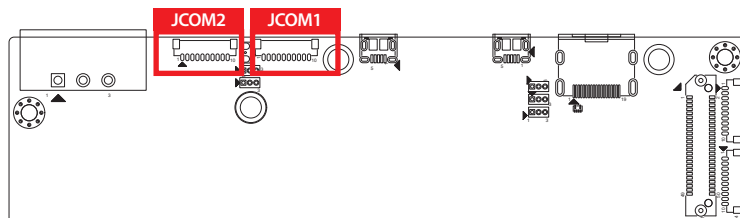

2.3.1.3 Console Port

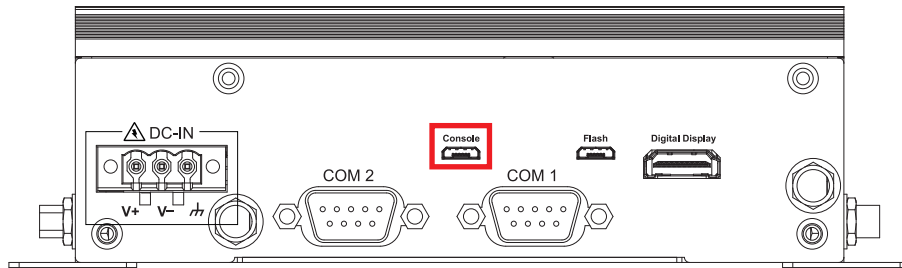

System debug Port, Micro USB to UART that connects to the SOM serial console.
Console Port Pin Out of Micro USB :

Pin No.	Function	Pin No.	Function
1	+V5	2	USB_DATA-
3	USB_DATA+	4	NC
5	GND		

2.3.1.4 System Recovery Port

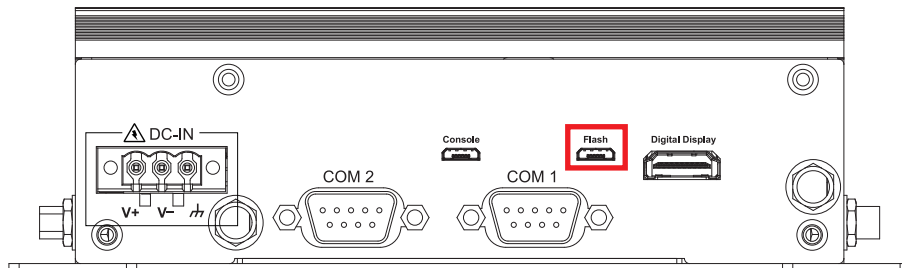

The EAC-2000 USB Recovery mode provides an alternate boot device (USB). In this mode, the system is connected to a host system and boots over USB. This is used when a new image needs to be flashed. USB0 must be available to use as USB Device for USB Recovery Mode.

Pin No.	Function	Pin No.	Function
1	VBUS_DET	2	USB_DATA-
3	USB_DATA+	4	NC
5	GND		

2.3.1.5 Digital Display Port

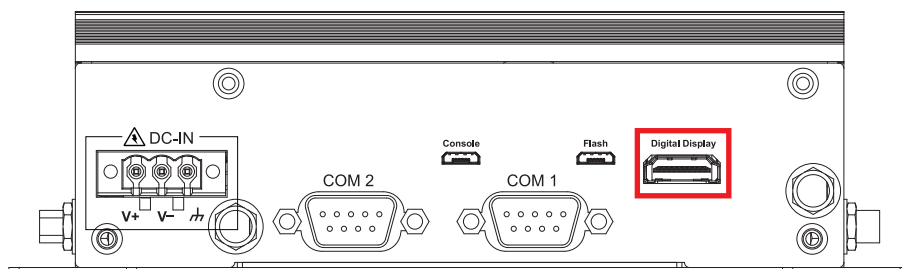

The Digital Display Ports support HDMI V2.0 interface, connection supports up to 3840 x 2160 @60Hz

2.3.2 Functions of EAC-2100

2.3.2.1 CAN Port

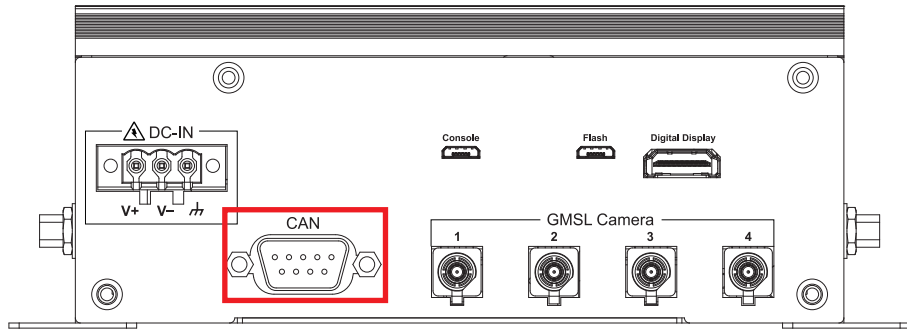

CAN Bus Connector Pin Out :

CAN Port	Pin No.	Description	Pin No.	Description
1	1	-----	2	CANL
	3	GND	4	-----
	5	-----	8	-----
	7	CANH	8	-----
	9	-----		

CAN Bus Connector Pin Out :

CAN Port	MB Connector
CAN	JCAN1

JCAN1 MB connector pin out :

CAN Port	Pin No.	Description	Pin No.	Description
JCAN1 (CAN)	1	+3.3V	2	CAN_L
	3	CAN_H	4	GND

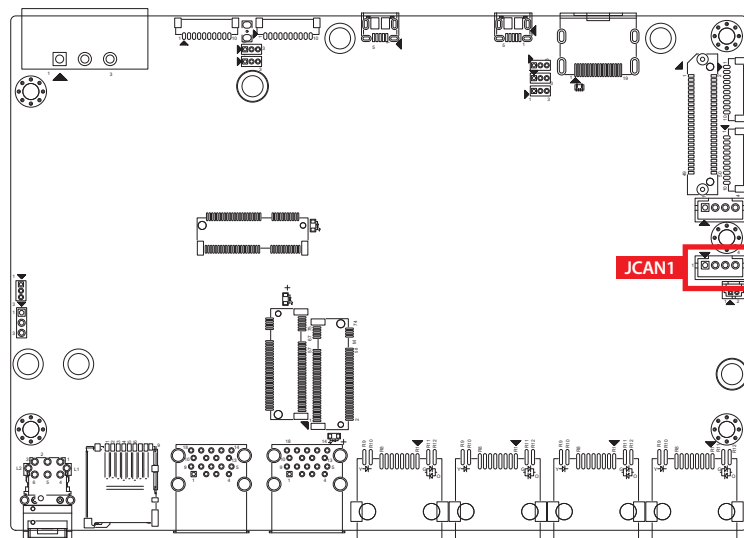

2.3.2.2 GMSL Camera Port

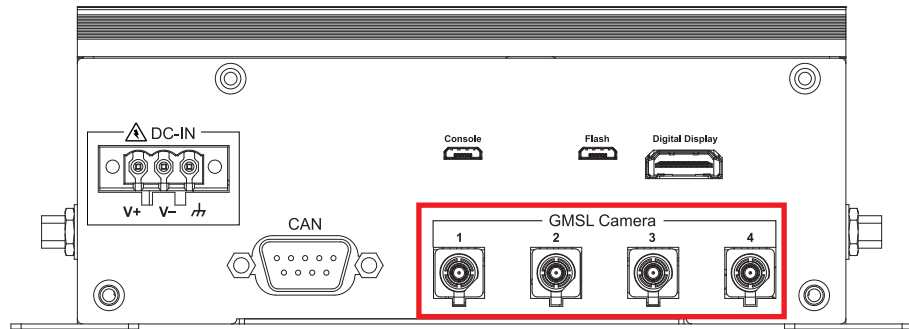

There are four FAKRA connectors in the front side of EAC-2100. Each camera connects to the EAC-2100 through a single coax cable. Using GMSL2 (Gigabit Multimedia Serial Link) connections, the cameras are connected to a two-port deserializer. The output of the deserializer is MIPI CSI-2.

2.4 Main Board Connector & Jumper Locations

2.4.1 TOP View of MB

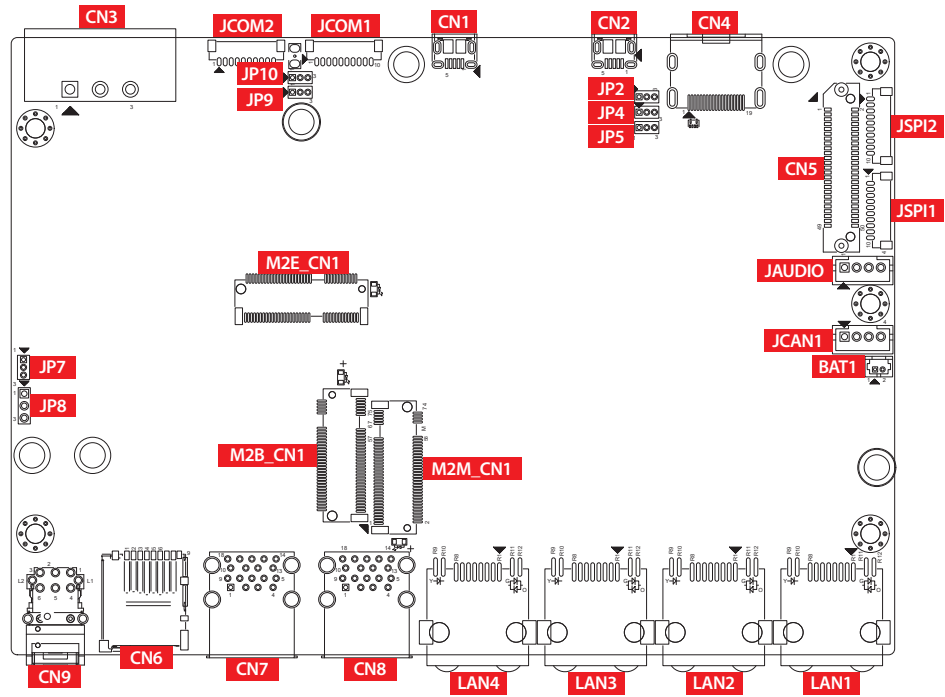

2.4.2 BOT View of MB

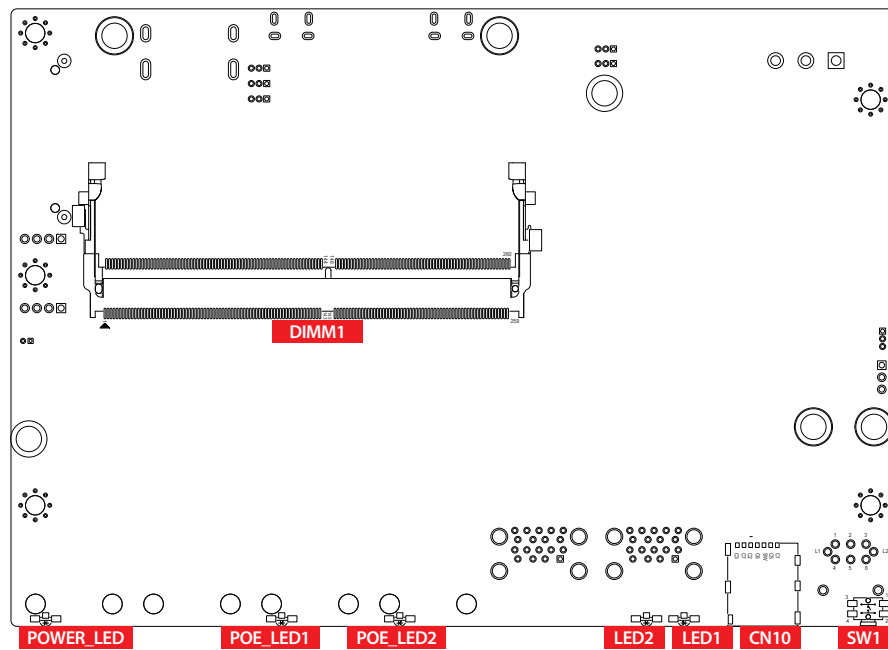

2.4.3 JCOM1, JCOM2 Connector

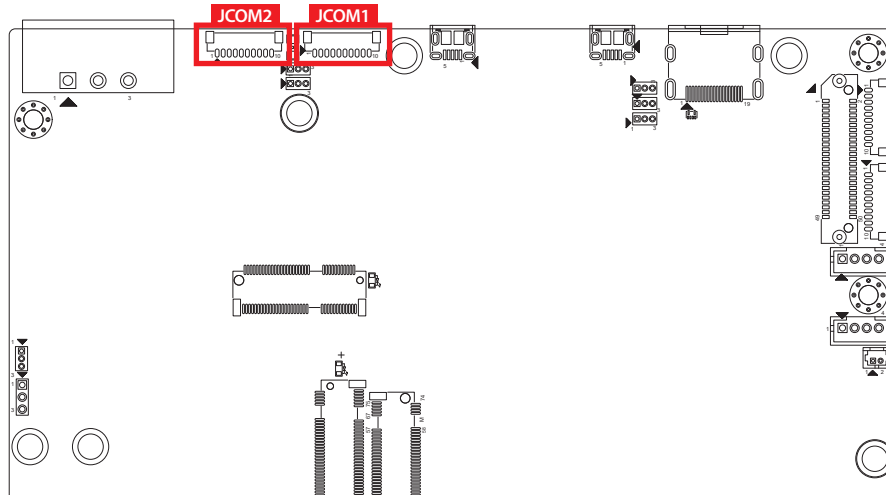

Pin No.	Description	Pin No.	Description
1	-----	6	TXD
2	Ground	7	RTS
3	-----	8	RXD
4	-----	9	-----
5	CTS	10	-----

2.4.4 M2E_CN1 : M.2 KEY-E

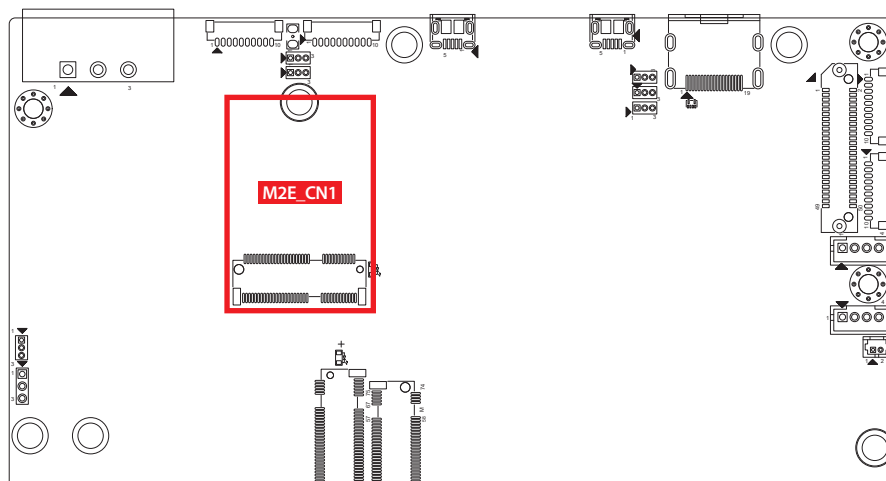

M.2 KEY E : USB 2.0/PCIe x1 M.2 key E connector is suitable for applications that use wireless connectivity including Wi-Fi, Bluetooth, NFC or GNSS. Module card types include 2230.

Pin Out :

Pin No.	Signal Name	Pin No.	Signal Name
75	GND	74	+V3.3_AUX
73	NC	72	+V3.3_AUX
71	NC	70	PEWAKE
69	GND	68	NC
67	NC	66	NC
65	NC	64	NC
63	GND	62	I2C_ALERT#
61	NC	60	I2C_CLK
59	NC	58	I2C_DATA
57	GND	56	NC
55	PCIE_WAKE#	54	NC
53	PCIE_CLK_REQ0#	52	PLTRST#
51	GND	50	SUS_CLK
49	PCIE_100M_CLK__N	48	NC
47	PCIE_100M_CLK__P	46	NC
45	GND	44	NC
43	PCIE_RX_N	42	NC
41	PCIE_RX_P	40	NC
39	GND	38	NC
37	PCIE_TX_N	36	NC
35	PCIE_TX_P	34	NC
33	GND	32	NC
Mechanical Key			
23	NC		
21	NC	22	NC
19	GND	20	NC
17	NC	18	GND
15	NC	16	NC
13	GND	14	NC
11	NC	12	NC
9	NC	10	NC
7	GND	8	NC
5	USB-	6	LED1#
3	USB+	4	+V3.3_AUX
1	GND	2	+V3.3_AUX

2.4.5 M2B_CN1 : M.2 KEY-B

M.2 key B Connector (3042/3052, PCIe Gen2x1, USB 3.0, USB 2.0)

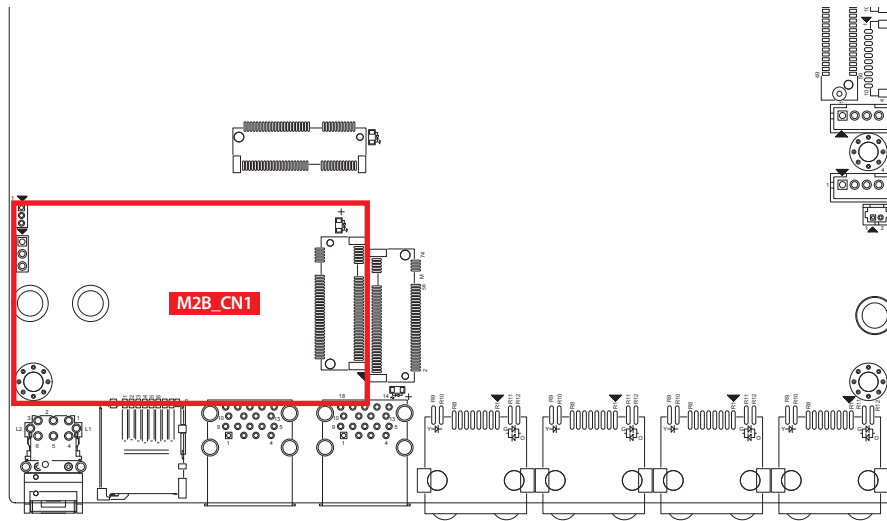

2.4.6 M2M_CN1 : M.2 KEY-M

M.2 key M Connector (2280, PCIe Gen3x1)

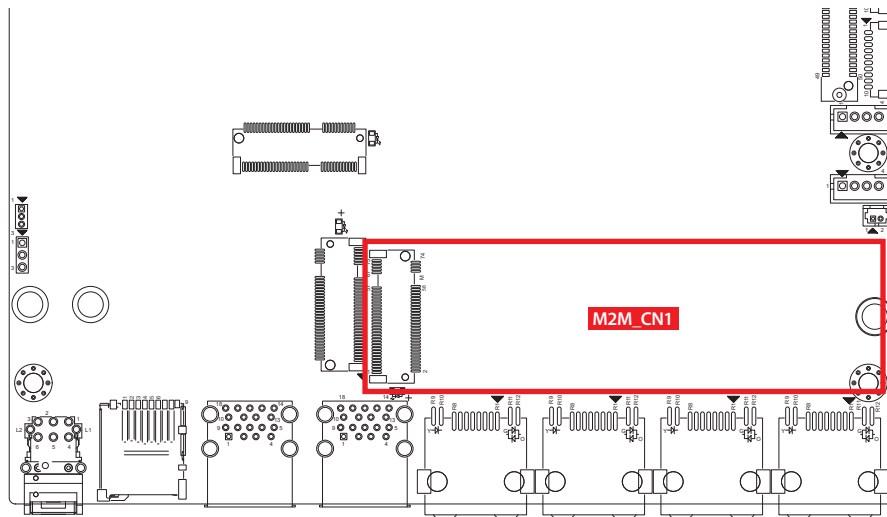

2.4.7 CN5 : Board to Board Connector for Camera Board (EAC-2000-CB)

Camera connector; enables use of CSI cameras. The EAC-2100 works with Sony IMX390 camera modules, including oToBrite oToCAM264ISP-L61M camera module.

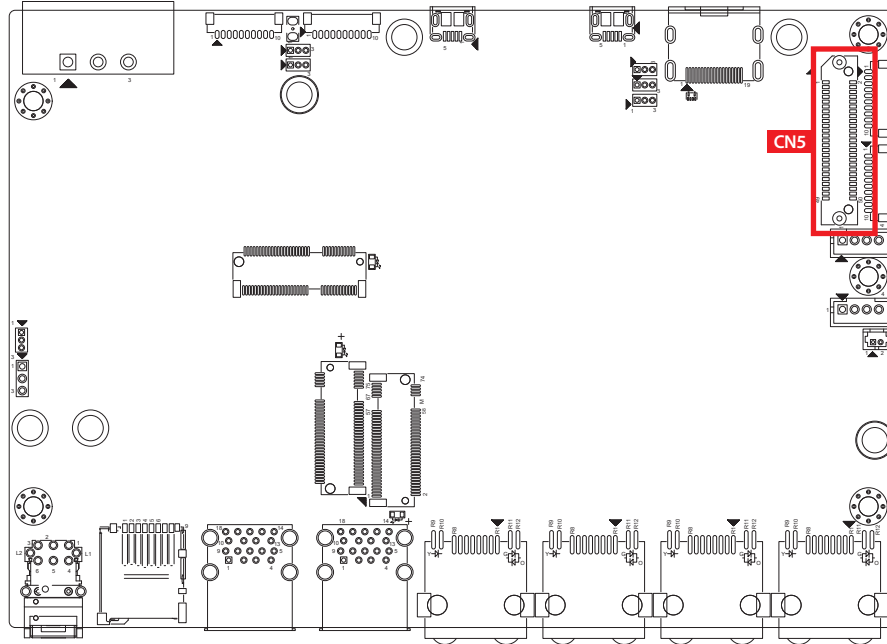

Pin No.	Definition	Pin No.	Definition	Pin No.	Definition	Pin No.	Definition
1	GND	27	CAM0_MCLK	2	P12V	28	CAM_I2C_SCL
3	CAM1_MCLK	29	CAM0_PWDN	4	P12V	30	CAM_I2C_SDA
5	CAM1_PWDN	31	GND	6	P12V	32	GPIO06_LS
7	GND	33	CSI0_D1_P	8	GPIO01_LS	34	-----
9	CSI2_D1_P	35	CSI0_D1_N	10	-----	36	-----
11	CSI2_D1_N	37	GND	12	-----	38	GND
13	GND	39	CSI0_CLK_P	14	GND	40	CSI1_D1_P
15	CSI2_CLK_P	41	CSI0_CLK_N	16	CSI3_D1_P	42	CSI1_D1_N
17	CSI2_CLK_N	43	GND	18	CSI3_D1_N	44	GND
19	GND	45	CSI0_D0_P	20	GND	46	CSI1_D0_P
21	CSI2_D0_P	47	CSI0_D0_N	22	CSI3_D0_P	48	CSI1_D0_N
23	CSI2_D0_N	49	GND	24	CSI3_D0_N	50	GND
25	GND			26	GND		

2.4.8 JAUDIO : Speaker Out Connector

To drive moving coil loudspeakers only. Speaker impedance must be 4Ω or more.

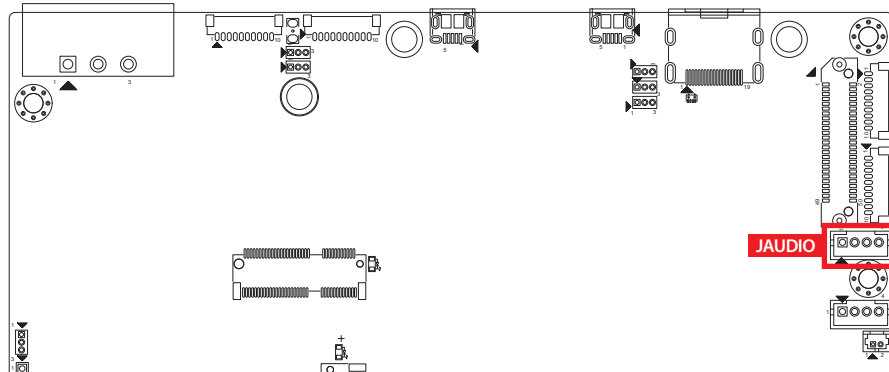

Pin No.	Description	Pin No.	Description
1	OUTP_L	2	OUTN_L
3	OUTP_R	4	OUTN_R

2.4.9 JCAN1 : CAN BUS Connector

EAC-2000 has a single controlled area network (CAN) interface to the JCAN1 connector.

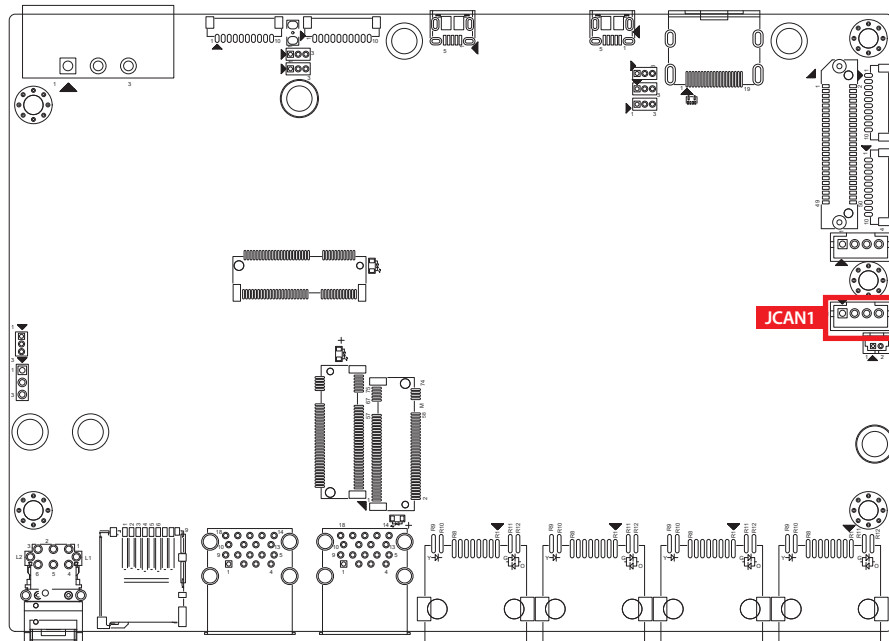

JCAN1 MB connector pin out :

Pin No.	Description	Pin No.	Description
1	+3.3V	2	CAN_L
3	CAN_H	4	GND

2.4.10 JSPI1, JSPI2 : SPI/I2C Signal Connector

There are two SPI+I2C headers, it offered SPI Bus and I2C Bus, in EAC-2000 series.

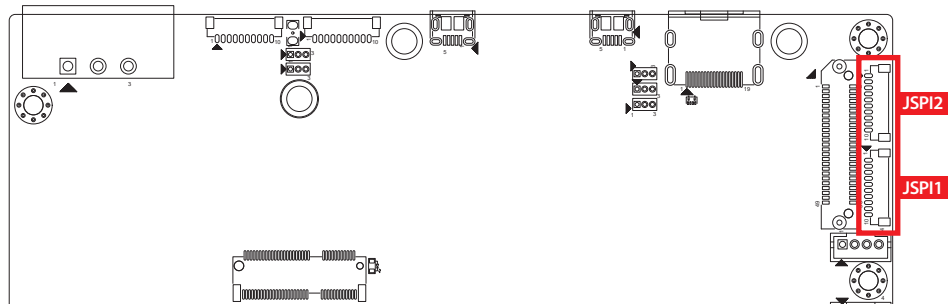

Pin No.	JSPI1 Definition	Pin No.	JSPI2 Definition
1	+3.3V	1	+3.3V
2	GND	2	GND
3	SPI0_MOSI	3	SPI1_MOSI
4	SPI0_MISO	4	SPI1_MISO
5	SPI0_CS0	5	SPI1_CS0
6	SPI0_SCK	6	SPI1_SCK
7	SPI0_CS1	7	SPI1_CS1
8	-----	8	-----
9	I2C1_SDA	9	I2C2_SDA
10	I2C1_SCL	10	I2C2_SCL

2.4.11 BAT1 : RTC Battery Connector

The system's real-time clock is powered by a lithium battery. It is Equipped with Panasonic BR2032 190mAh lithium battery. It is recommended that you not replace the lithium battery on your own. If the battery needs to be changed, please contact the Vecow RMA service team.

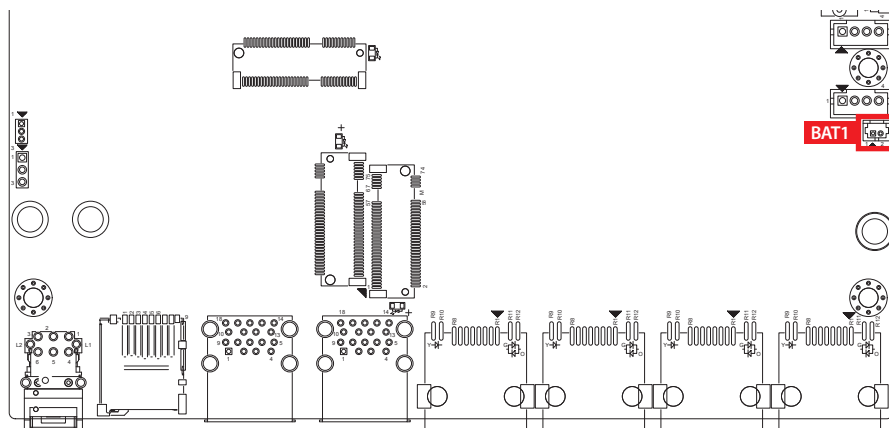

2.4.12 DIMM1 : SO-DIMM connector only for Jetson Xavier NX module

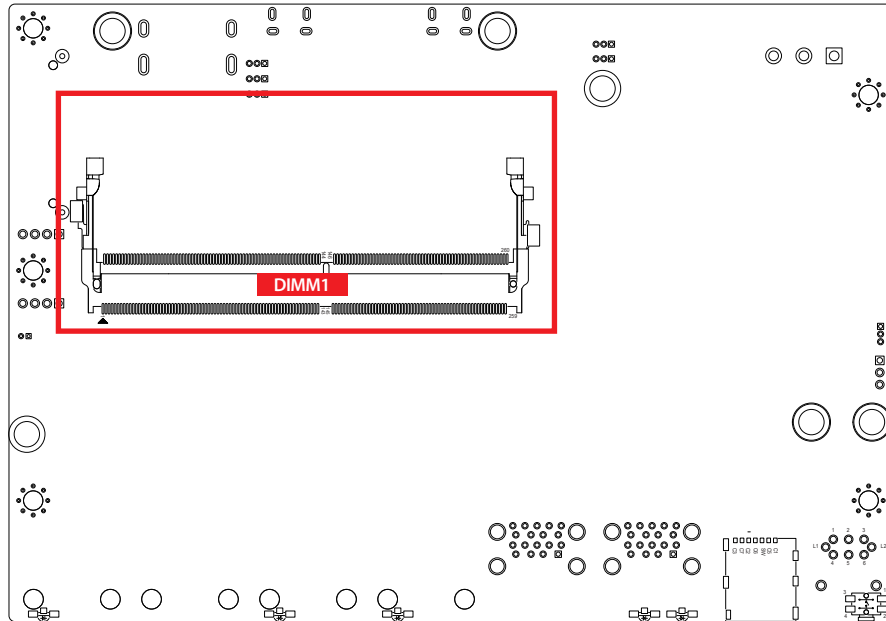

2.5 Main Board Jumper Settings

2.5.1 Board Top View of EAC-2000 Main Board with Jumper

The figure below is the top view of EAC-2000 main board which is the main board. It shows the location of the jumpers.

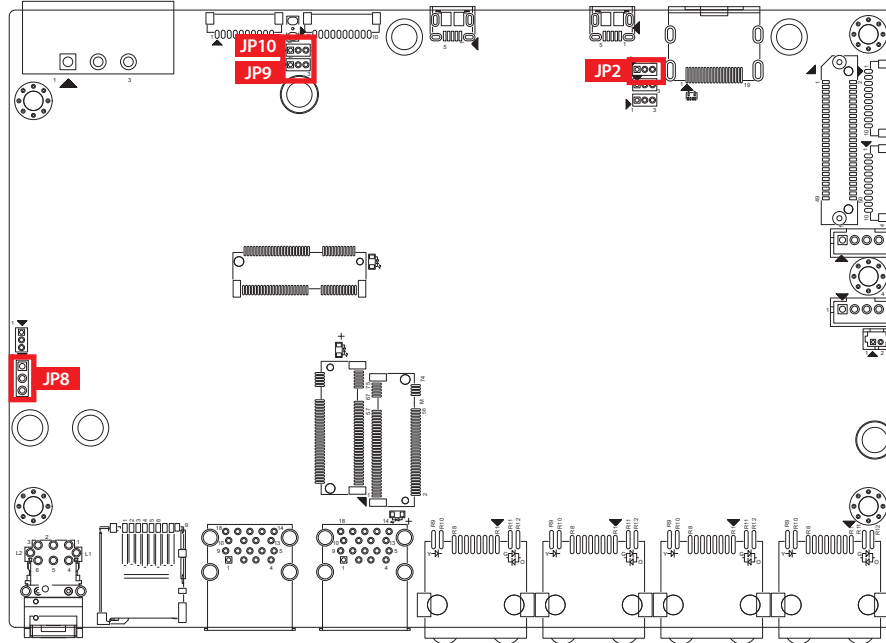

You may configure your card to match the needs of your application by setting jumpers. A jumper is a metal bridge used to close an electric circuit. It consists of two metal pins and a small metal clip (often protected by a plastic cover) that slides over the pins to connect them. To "close" a jumper, you connect the pins with the clip. To "open" a jumper, you remove the clip. Sometimes a jumper will have three pins, labeled 1, 2 and 3. In this case you would connect either pins 1 and 2, or 2 and 3.

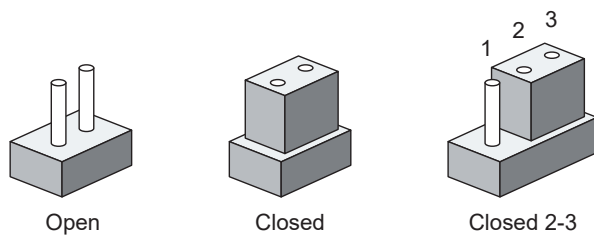

2.5.2 JP2 : Auto Power ON Enable/Disable Jumper

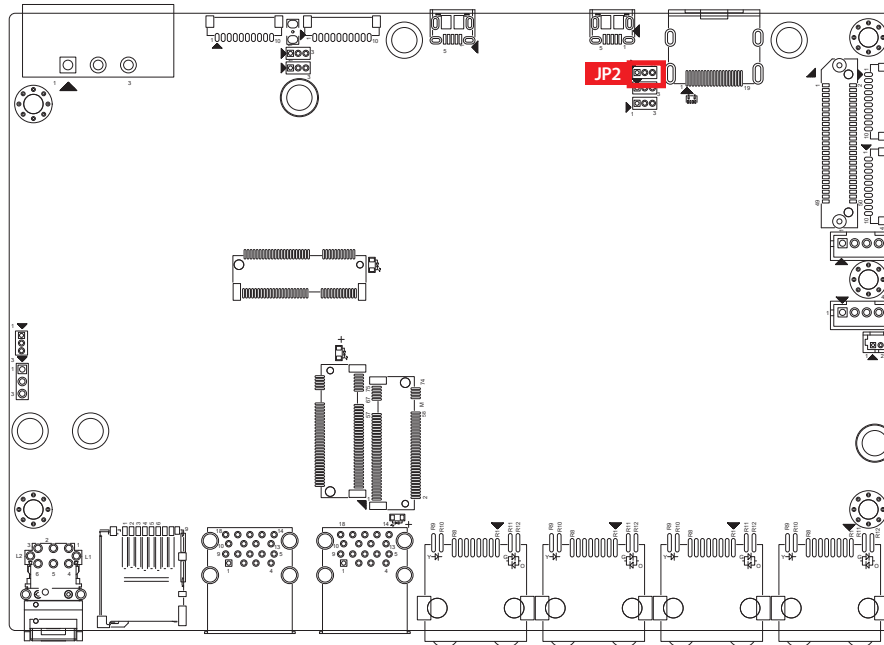

Setting	Function
1-2	Auto Power ON Enable (Default)
2-3	Auto Power ON Disable

2.5.3 JP8 : POE Power On Voltage Select

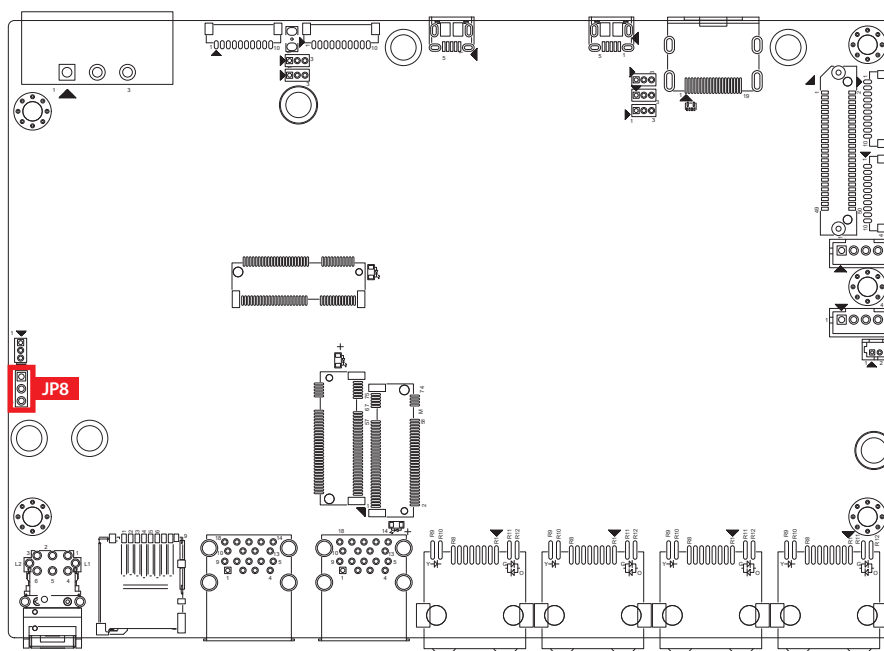

Setting	Function
1-2	POE Power On Voltage 12V (Default)
2-3	POE Power On Voltage 3.3V

2.5.4 JP9, JP10 : COM1, COM2 RS485 Mode Terminal resistance ON/OFF

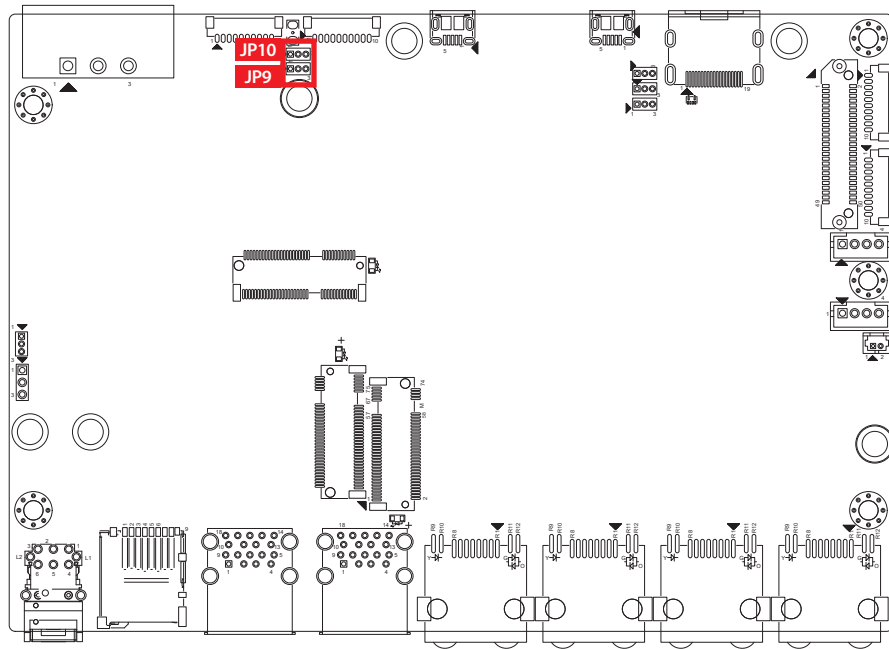

There are two Pin Header JP9 and JP10 to set terminal resistor (120Ω) ON/OFF of COM RS485 mode function.

Jumper	Setting	Function
JP9 (COM1)	1-2	RS485 Mode Terminal resistance OFF (Default)
	2-3	RS485 Mode Terminal resistance ON
JP10 (COM1)	1-2	RS485 Mode Terminal resistance OFF (Default)
	2-3	RS485 Mode Terminal resistance ON

2.6 Expansion Board Connectors & Jumper Locations

2.6.1 TOP View of Daughter Board

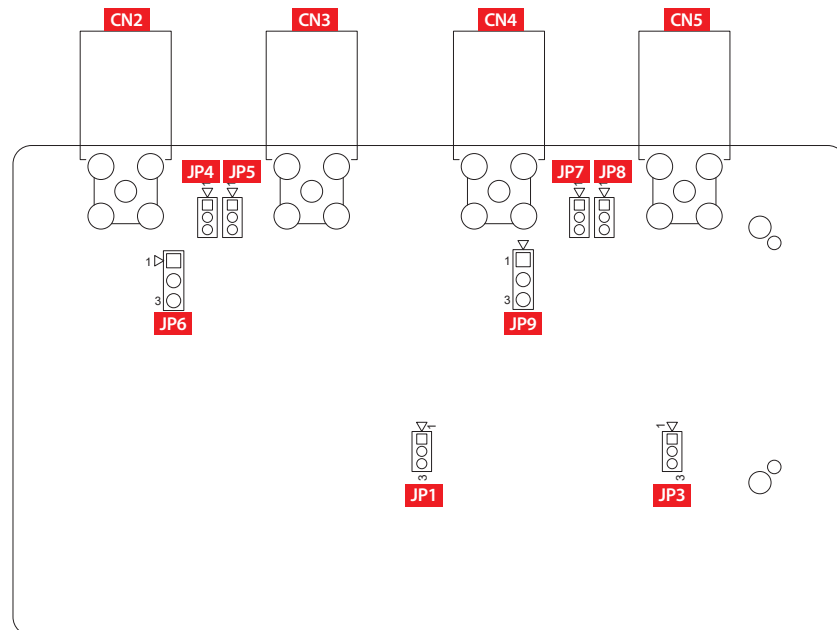

2.6.2 BOT View of Daughter Board

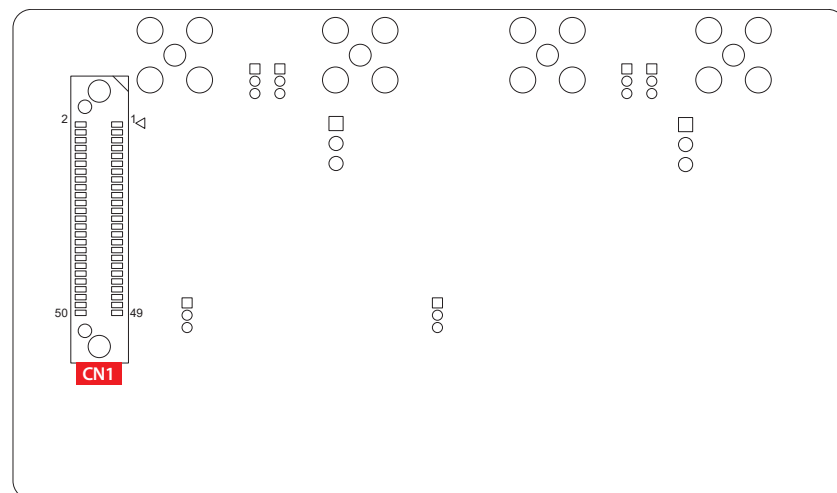

2.6.3 CN2, CN3, CN4, CN5, FAKRA Connector single Z Code

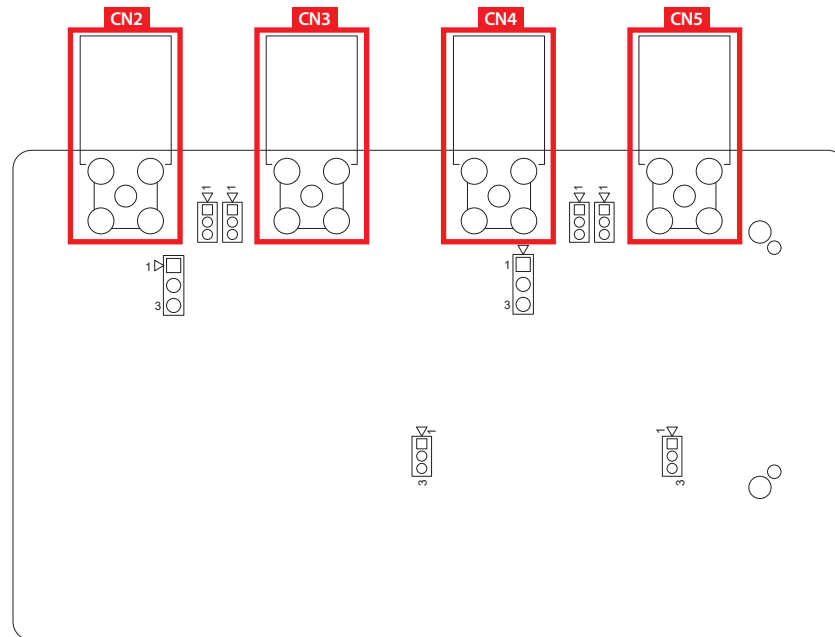

There are four FAKRA connectors in EAC-2100 series. Connect four GMSL2 cameras using FAKRA coax cables. CN2, CN3 and CN4, CN5 are connected to each two-port deserializer.

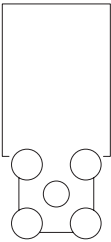
	Part location	Definition
	CN2	Coax Serial-Data Input/Output 1
	CN3	Coax Serial-Data Input/Output 2
	CN4	Coax Serial-Data Input/Output 3
	CN5	Coax Serial-Data Input/Output 4

**2.6.4 JP1 : GMSL2 Rate setting for CN2 and CN3
 JP3 : GMSL2 Rate setting for CN4 and CN5**

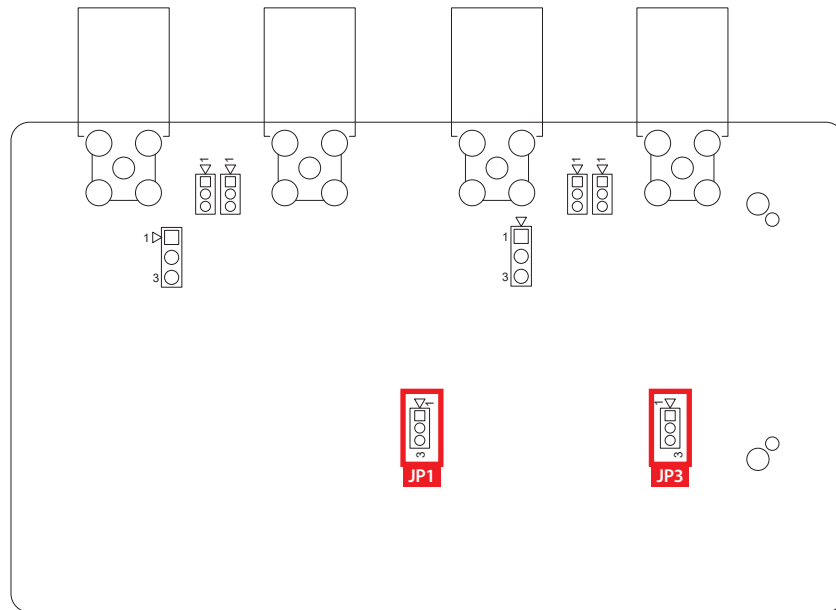

The GMSL2 forward link has a fixed link rate of 3Gbps or 6Gbps.

JP1 and JP3 Pin define :

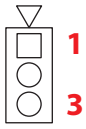
	Pin No.	Definition
	1	GMSL2_6G_2
	2	CFG1_2
	3	GMSL2_3G_2

JP1 and JP3 Jumper setting :

Jumper pin	GMSL 2 rate
*1-2	6 Gbps (Default)
2-3	3 Gbps

2.6.5 JP4, JP5, JP6 : POC (Power over coax) output voltage setting for CN2 and CN3

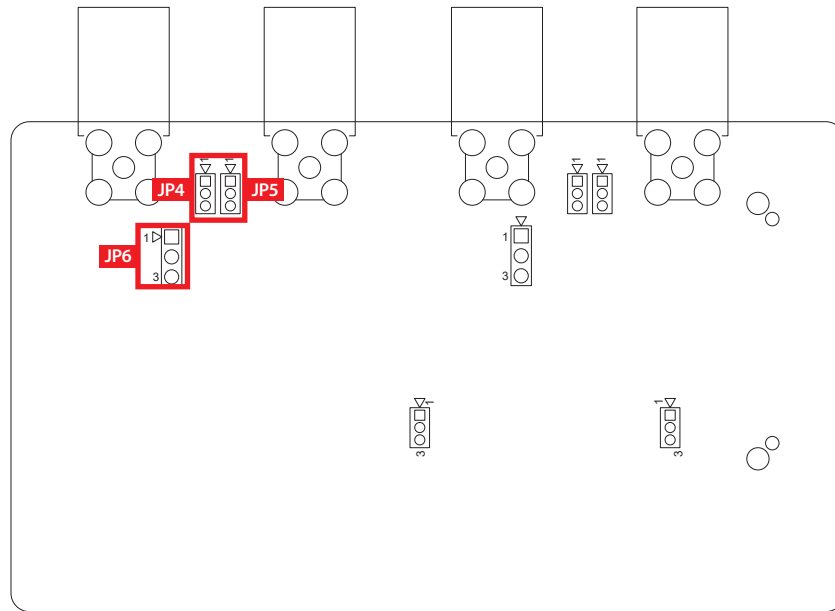

The EAC-2100 supports power over coax and provides +5V or +12V voltage outputs.

JP4 Pin define :

	Pin No.	Definition
	1	CAM_FB1_12V
	2	CAM_FB1
	3	CAM_FB1_5V

JP4 Jumper setting :

Jumper pin	POC voltage of CN2
*1-2	+12V (Default)
2-3	+5V

Used to set overcurrent protection IC output voltage for CN2.

JP5 Pin define :

	Pin No.	Definition
	1	CAM_FB2_12V
	2	CAM_FB2
	3	CAM_FB2_5V

JP5 Jumper setting :

Jumper pin	POC voltage of CN3
*1-2	+12V (Default)
2-3	+5V

Used to set overcurrent protection IC output voltage for CN3.

JP6 Pin define :

	Pin No.	Definition
	1	VDD12V
	2	VPOC_IN1
	3	VDD5V

JP6 Jumper setting :

Jumper pin	POC voltage of CN3
*1-2	+12V (Default)

The voltage is fixed at +12V when POC output from overcurrent Protection IC and will adjusted at +12V or +5V when POC not output from overcurrent Protection IC.

2.6.6 JP7, JP8, JP9 : POC (Power over coax) output voltage setting for CN4 and CN5

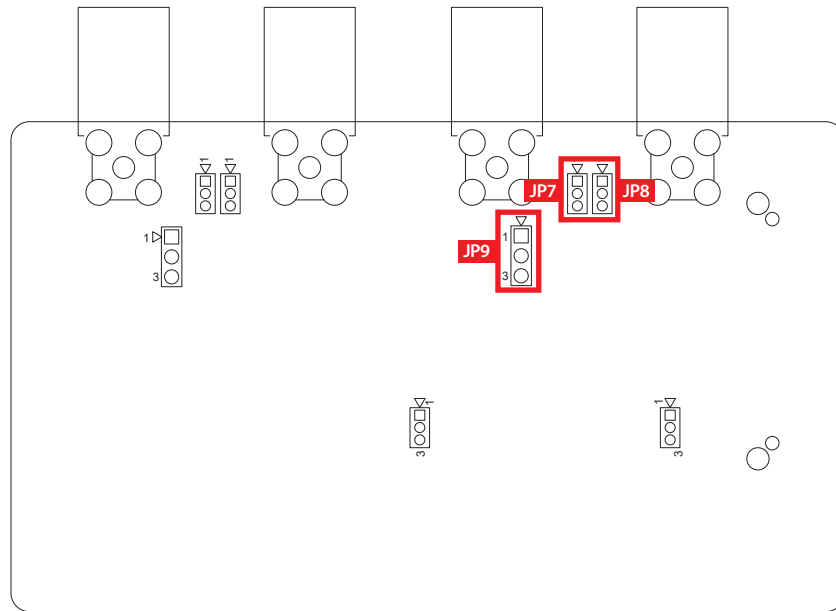

The EAC-2100 supports power over coax and provides +5V or +12V voltage outputs.

JP7 Pin define :

	Pin No.	Definition
	1	CAM_FB3_12V
	2	CAM_FB3
	3	CAM_FB3_5V

JP7 Jumper setting :

Jumper pin	POC voltage of CN4
*1-2	+12V (Default)
2-3	+5V

Used to set overcurrent protection IC output voltage for CN4.

JP8 Pin define :

	Pin No.	Definition
	1	CAM_FB4_12V
	2	CAM_FB4
	3	CAM_FB4_5V

JP8 Jumper setting :

Jumper pin	POC voltage of CN5
*1-2	+12V (Default)
2-3	+5V

Used to set overcurrent protection IC output voltage for CN3.

JP9 Pin define :

	Pin No.	Definition
	1	VDD12V
	2	VPOC_IN2
	3	VDD5V

JP9 Jumper setting :

Jumper pin	POC voltage of CN4 and CN5
*1-2	+12V (Default)
2-3	+5V

The voltage is fixed at +12V when POC output from overcurrent Protection IC and will adjusted at +12V or +5V when POC not output from overcurrent Protection IC.

2.6.7 CN1 : 50-Pin board to board connector

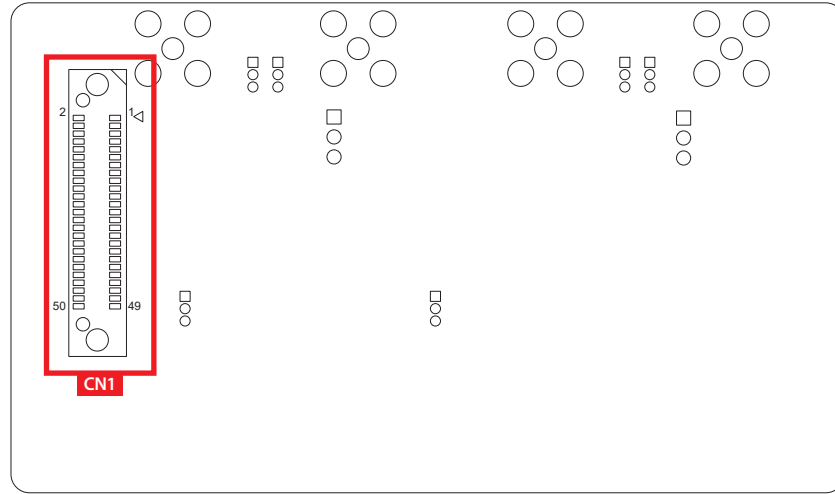

Pin No.	Definition	Pin No.	Definition
1	GND	2	+12V
3	CAM1_MCLK	4	+12V
5	CAM1_PWDN	6	+12V
7	GND	8	MFP0_2
9	CSI2_D1_P	10	MFP5_2
11	CSI2_D1_N	12	MFP6_2
13	GND	14	GND
15	CSI2_CLK_P	16	CSI3_D1_P
17	CSI2_CLK_N	18	CSI3_D1_N
19	GND	20	GND
21	CSI2_D0_P	22	CSI3_D0_P
23	CSI2_D0_N	24	CSI3_D0_N
25	GND	26	GND
27	CAM0_MCLK	28	CAM_I2C_SCL
29	CAM0_PWDN	30	CAM_I2C_SDA
31	GND	32	MFP0_1
33	CSI0_D1_P	34	MFP5_1
35	CSI0_D1_N	36	MFP6_1
37	GND	38	GND
39	CSI0_CLK_P	40	CSI1_D1_P
41	CSI0_CLK_N	42	CSI1_D1_N
43	GND	44	GND
45	CSI0_D0_P	46	CSI1_D0_P
47	CSI0_D0_N	48	CSI1_D0_N
49	GND	50	GND

3

SYSTEM SETUP

3.1 How to Open Your EAC-2000/2100

Remove four F-M3x4L screws and pick up bottom cover.

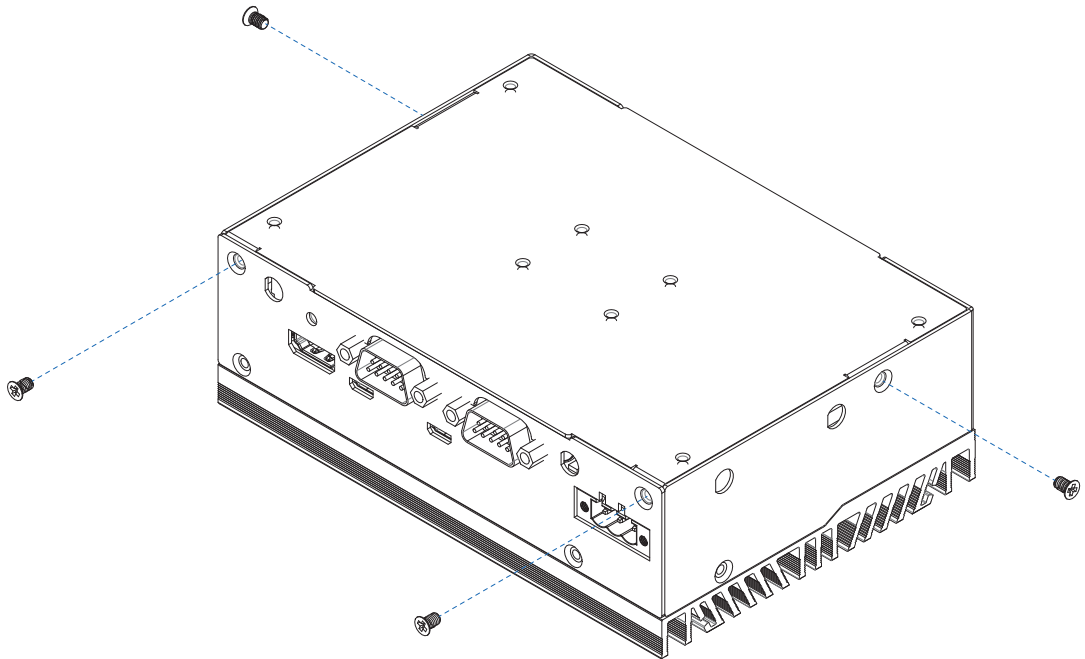

3.2 Installing Nano SIM Card

Step 1 Remove one F-M3x4L screw on SD/SIM cover.

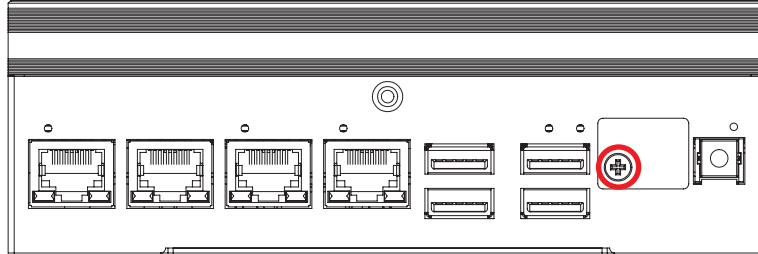

Step 2 Inserting SIM card, make sure the system power is not plugged.

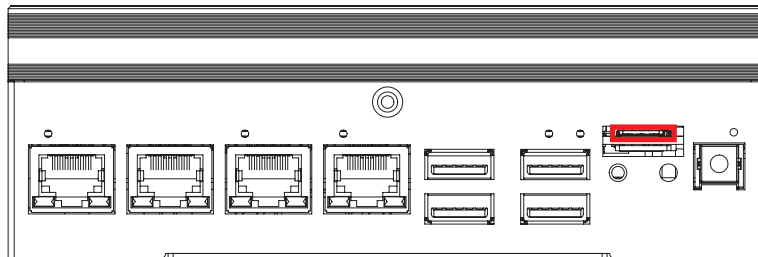

3.3 Installing Micro SD Card

Step 1 Remove one F-M3x4L screw on SD/SIM cover.

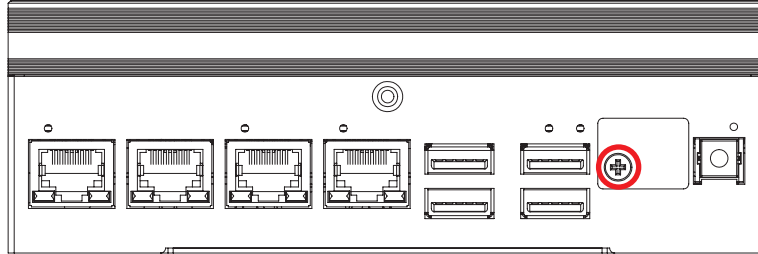

Step 2 Inserting SD card.

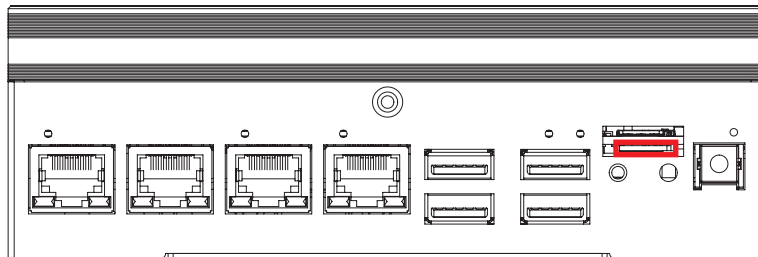

3.4 Installing M.2

3.4.1 M.2 Key B (3042), M.2 Key E (2230), M.2 Key M (2280)

Install M.2 card into the M.2 slot and fasten PHILLIPS-M3x4L screw.

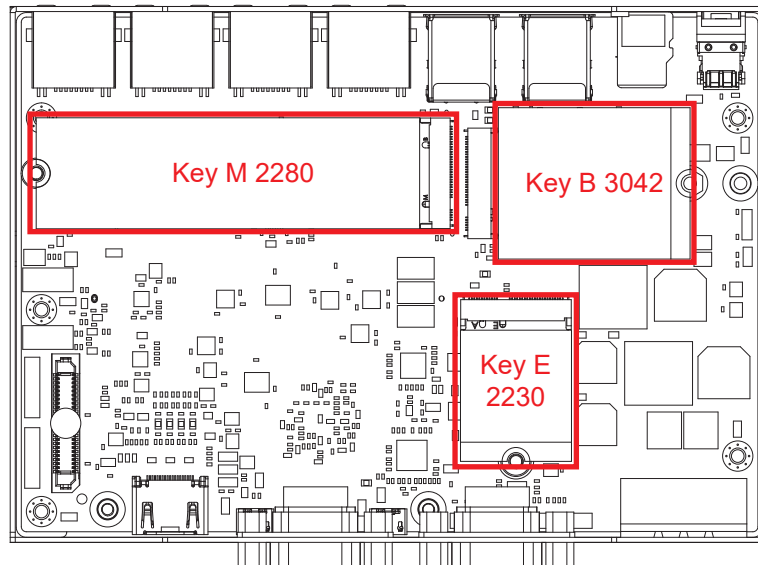

3.4.2 M.2 Key B (3052)

3.4.2-1 Change the stud position.

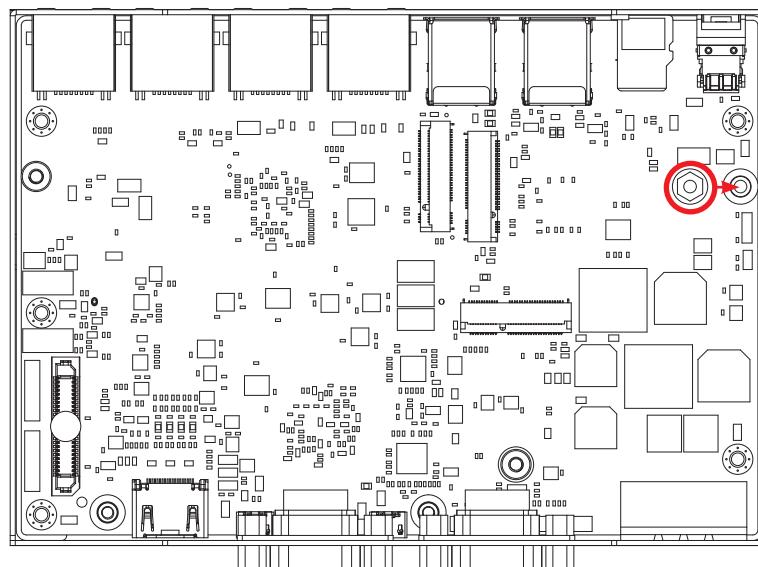

3.4.2-2 Install M.2 card into the M.2 slot and fasten PHILLPIS-M3x4L screw.

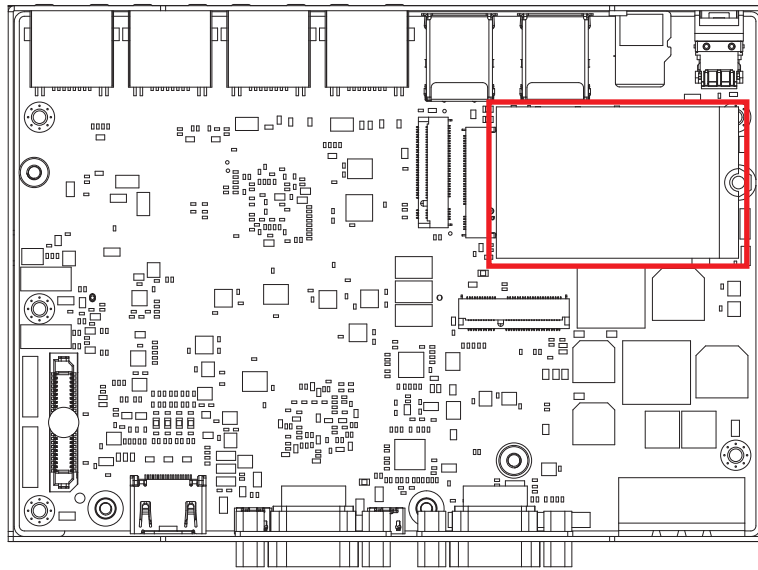

3.5 Installing Antenna Cable

Step 1 Remove the rubber corks on the panel.

Step 2 Put antenna cable connector into the hole on panel.

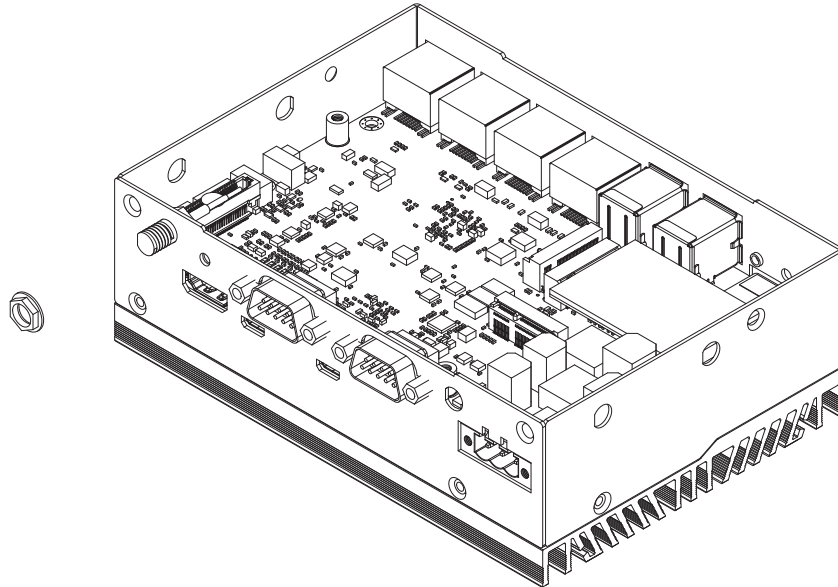

Step 3 Fasten washer on the antenna cable connector.

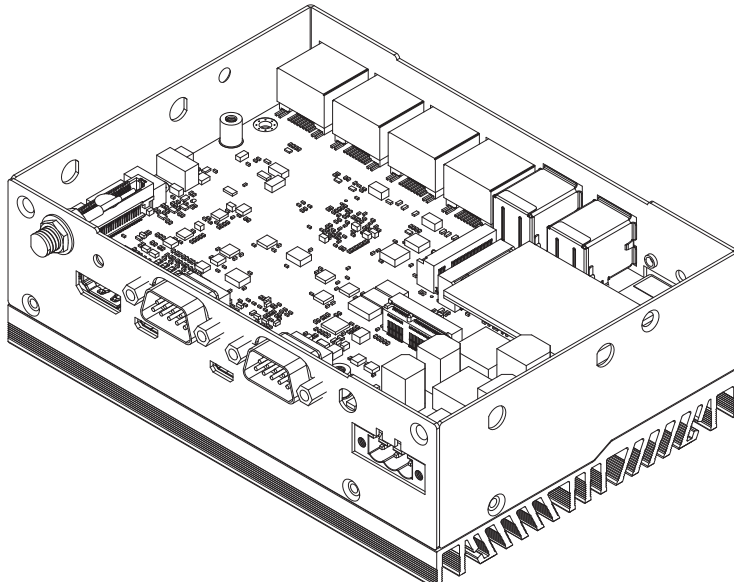

3.6 Mounting Your EAC-2000/2100

Wall Mount

Install wall mount bracket then fasten four pcs F-M3x4L screws.

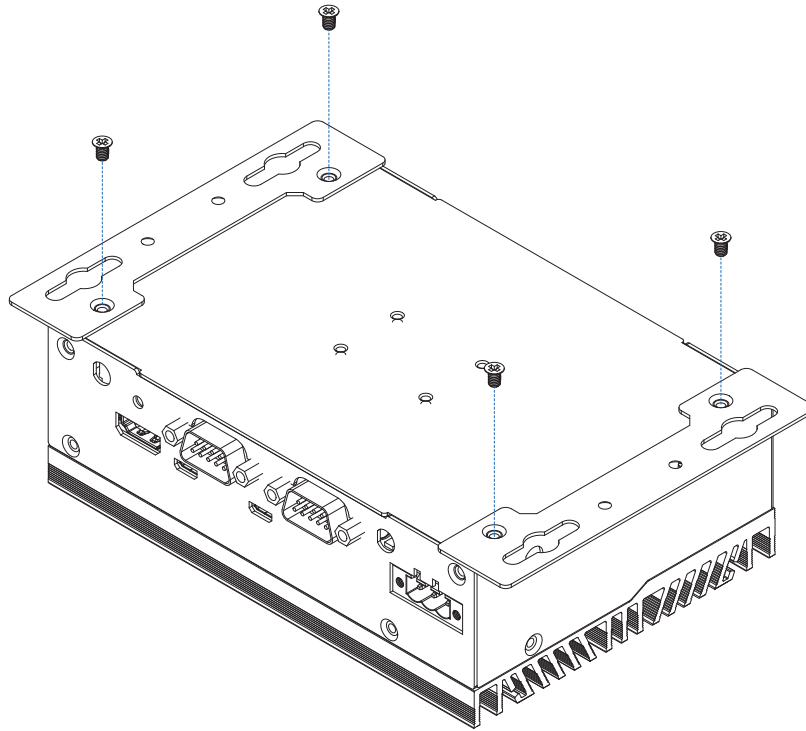

DIN Rail Mount

Install din rail kit then fasten screws.

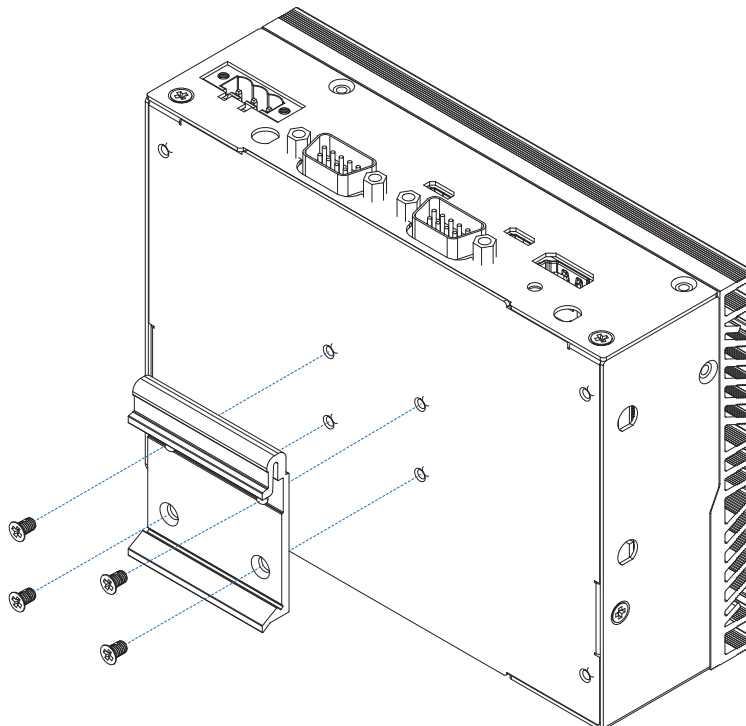

4

SOFTWARE SETUP

4.1 Peripheral Interface Guide

4.1.1 Serial Port

1. **EAC-2000/2100** have two RS-232/485 serial port for connection.

To switch the type of your serial ports, you can issue the following commands :

Set COM1 to 232 Mode :

```
$ sudo setcom 1 232
```

Set COM1 to 485 Mode :

```
$ sudo setcom 1 485
```

Set COM2 to 232 Mode :

```
$ sudo setcom 2 232
```

Set COM2 to 485 Mode :

```
$ sudo setcom 2 485
```

4.1.2 CAN Bus

You can issue the following commands to turn on CAN FD mode :

```
$ sudo modprobe can
```

```
$ sudo modprobe can-raw
```

```
$ sudo modprobe mttcan
```

```
$ ip link set can0 up type can bitrate 125000
```

4.1.3 I2S

EAC-2000/2100 have an internal I2S connector, issue the following commands before you start to play audio by I2S :

```
$ amixer -c 1 cset name="I2S1 Mux" "I2S5"
```

Turn on the I2S audio :

```
$ sudo set_audio 1
```

Turn off the I2S audio :

```
$ sudo set_audio 0
```

Play music :

```
$ aplay music.wav
```

4.1.4 User Defined LED

You can access the following path to find a user defined LED example application :

```
$ cd /usr/src/tools/led/
```

4.1.5 Watch Dog

You can access the following path to find an example application for watch dog :

```
$ cd /usr/src/tools/watchdog/
```

4.2 Determine Available Drive Space

To determine the amount of available drive space, you can issue the following commands :

```
$ sudo df -h
```

4.3 Install the CUDA package

1. To install the CUDA package on EAC-2000/2100, you can issue the following commands :

```
$ sudo apt update
```

```
$ sudo apt install nvidia-cuda
```

4.4 Flash image to Your EAC-2000/2100

Before starting the flashing process, be sure you've properly turned off the EAC-2000/2100 and disconnected from the power. You also need to prepare a host PC running Ubuntu 16.04 or later.

4.4.1 Download the OS image file

Step.1 Download the OS image package file. The file name will be similar to :

EAC-2000_jetpack4.5.1_v1.00.tar

Step.2 On Host Computer, open a Linux terminal and issue the following command to extract compressed image files :

```
$ sudo tar zxvf EAC-2000_jetpack4.5.1.tar
```

4.4.2 Connect EAC-2000/2100 to the host computer

Step.1 Connect the Micro USB cable to the **"Flash"** Port on **EAC-2000/2100** and the other end to an available USB port on the **host PC**.

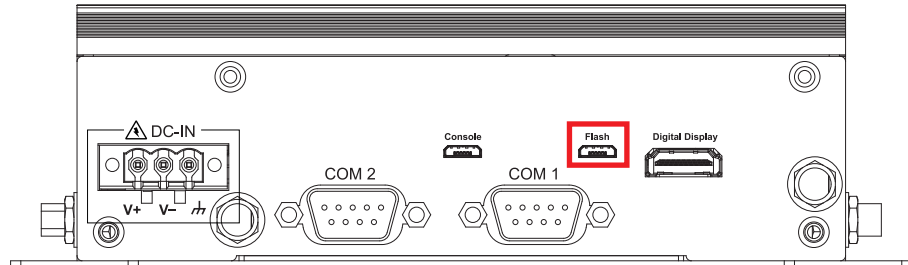

Step.2 Press and hold the **"RECOV"** button.

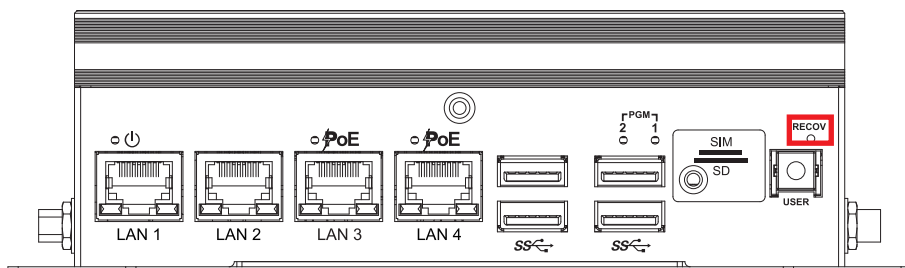

and **connect the power adapter**. Continue to hold the **"RECOV"** button for **two seconds**, and release.

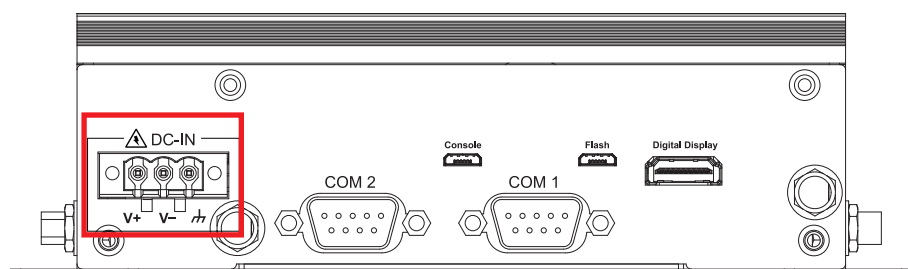

Step.3 Now device is in recovery mode, issue **"lsusb"** command on host PC will find a new USB device :

```
Bus 003 Device 005: ID 0955:7e19 NVidia Corp.
```

4.4.3 Flash image to the EAC-2000/2100

Step.1 Open a **terminal** on **host PC**, then access the **package folder** you extracted in the **4.4.1 section**.

Step.2 Issue the following command to flash the image :

```
$ sudo start_update.sh.
```

Step.3 Once the process finished, you should see the following log :

```
[ 704.7613 ]
[ 704.7778 ] tegradevflash_v2 --write BCT br_bct_BR.bct
[ 704.7801 ] Bootloader version 01.00.0000
[ 704.8029 ] Writing partition BCT with br_bct_BR.bct
[ 704.8047 ] [.....] 100%
[ 704.9767 ]
[ 704.9942 ] tegradevflash_v2 --write MB1_BCT mb1_cold_boot_bct_MB1_sigheader.t
[ 704.9995 ] Bootloader version 01.00.0000
[ 705.0298 ] Writing partition MB1_BCT with mb1_cold_boot_bct_MB1_sigheader.bct
[ 705.0325 ] [.....] 100%
[ 705.2634 ]
[ 705.2683 ] tegradevflash_v2 --write MB1_BCT_b mb1_cold_boot_bct_MB1_sigheader
[ 705.2727 ] Bootloader version 01.00.0000
[ 705.3114 ] Writing partition MB1_BCT_b with mb1_cold_boot_bct_MB1_sigheader.t
[ 705.3151 ] [.....] 100%
[ 705.5326 ]
[ 705.5420 ] tegradevflash_v2 --write MEM_BCT mem_coldboot_sigheader.bct.encrypt
[ 705.5462 ] Bootloader version 01.00.0000
[ 705.5739 ] Writing partition MEM_BCT with mem_coldboot_sigheader.bct.encrypt
[ 705.5777 ] [.....] 100%
[ 706.8899 ]
[ 706.8946 ] tegradevflash_v2 --write MEM_BCT_b mem_coldboot_sigheader.bct.encrypt
[ 706.8993 ] Bootloader version 01.00.0000
[ 706.9316 ] Writing partition MEM_BCT_b with mem_coldboot_sigheader.bct.encrypt
[ 706.9348 ] [.....] 100%
[ 708.2254 ]
[ 708.2257 ] Flashing completed

[ 708.2259 ] Coldbooting the device
[ 708.2648 ] tegrarcm_v2 --ismb2
[ 708.2973 ]
[ 708.3001 ] tegradevflash_v2 --reboot coldboot
[ 708.3023 ] Bootloader version 01.00.0000
[ 708.3256 ]
*** The target t186ref has been flashed successfully. ***
Reset the board to boot from internal eMMC.
```

A

APPENDIX A : GMSL Camera Guide (EAC-2100 only)

To initialize the GMSL camera, you can access the following path to find the camera scripts :

```
$ cd /usr/src/tools/gmsl_camera/
```

"init.sh" includes camera bring up script and camera driver installation.

"preview_imx390ISP_example.sh" includes the command to open the camera with GStreamer.

B

APPENDIX B : Power Consumption

Testing Board :	EAC-2000
RAM	8GB (On Board)
USB-1	Kingston DTSE9H 16GB Flash drive
USB-2	Kingston DTSE9G2 16GB Flash drive
USB-3	USB Keyboard AOPEN CMS-730
USB-4	USB Mouse HP G1K28AA
Micro SD	Sandisk Ultra 128GB
Storage	16 GB eMMC
M.2 KEY M	Transcend TS128GMTE110S 128GB
M.2 KEY B	Quectel EM06-E
M.2 KEY E	Intel AX210.NGWW
LAN 1	1.0 Gbps
LAN 2	1.0 Gbps
LAN 3	1.0 Gbps
LAN 4	1.0 Gbps
Graphics Output	HDMI
Power Plan	Default
Power Source	Chroma 62006P-100-25
Test Program	Stress-ng Test

B.1 NVIDIA Jetson Xavier NX System-On-Module

Power on and boot to Linux 64bit

CPU	Power Input	Linux 64bit			
		idle status CPU		Run BurnInTest/Stress-ng Test	
		Max Current	Max Consumption	Max Current	Max Consumption
NVIDIA Jetson Xavier NX System-On-Module	9V	1.678A	15.10W	2.181A	19.63W
	12V	1.267A	15.20W	1.662A	19.94W
	24V	0.664A	15.94W	0.865A	20.76W
	36V	0.462A	16.63W	0.602A	21.67W
	50V	0.344A	17.20W	0.442A	22.10W



APPENDIX C : Supported Expansion Module List

C.1 Supported 5G/4G/GPS List

Type	Model	Support Standard
M.2 KEY B	Quectel EM06-E	LTE Category 6 Worldwide LTE-A and UMTS/HSPA+ Coverage GPS/GLONASS/BeiDou (Compass)/Galileo/ QZSS (Optional)
M.2 KEY B	Quectel RM500Q-AE	5G sub-6GHz Worldwide 5G and LTE-A coverage GPS/GLONASS/BeiDou (Compass)/Galileo

C.2 Supported Wi-Fi/Bluetooth List

Type	Model	Support Standard
M.2 KEY E	Intel AC8265NGW	IEEE802.11 a/b/g/n/ac (2x2) BT 4.2
M.2 KEY E	SparkLAN WNFT-237ACN(BT)	IEEE802.11 a/b/g/n/ac (2x2) BT 5.0



For further support information, please visit www.vecow.com

This document is released for reference purpose only.

All product offerings and specifications are subject to change without prior notice.

No part of this publication may be reproduced in any form or by any means, electric, photocopying, or recording, without prior authorization from the publisher.

The rights of all the brand names, product names, and trademarks belong to their respective owners.

© Vecow Co., Ltd. 2023. All rights reserved.